

NX-SERIES

Technical Manual

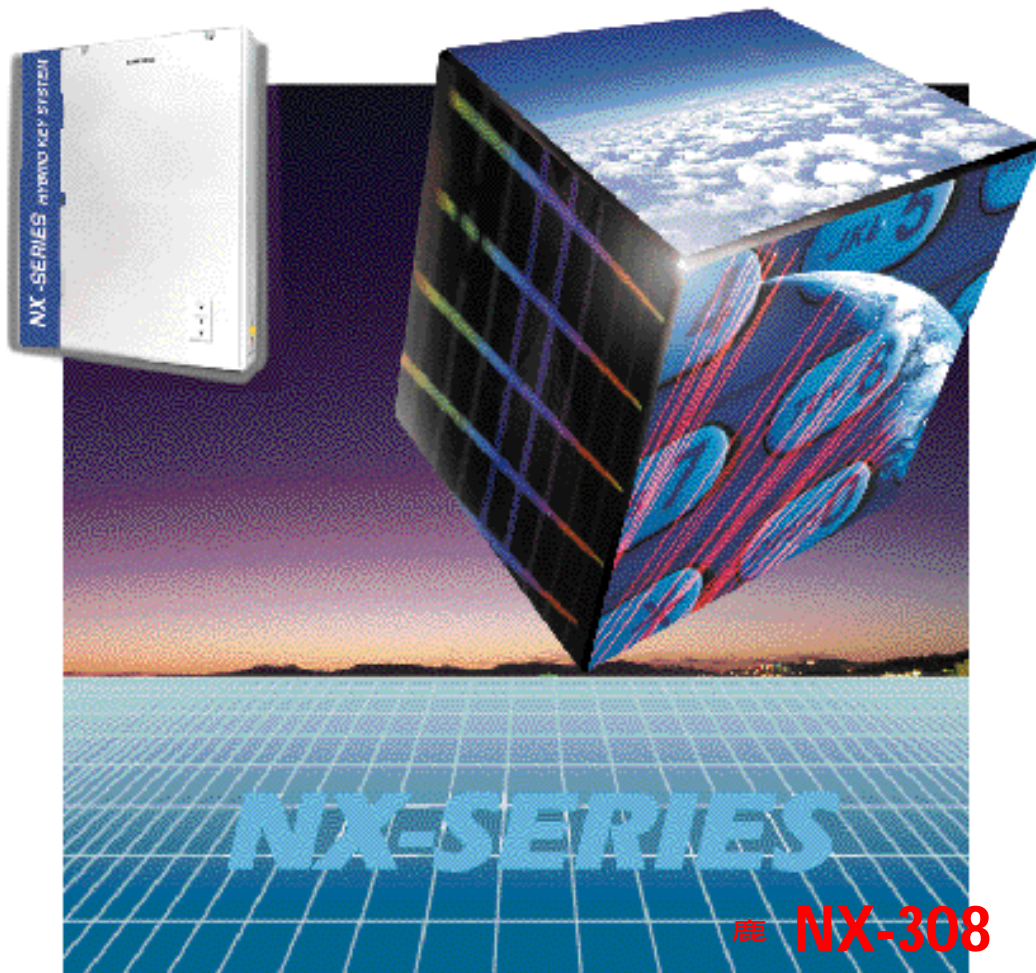

鹿 **NX-308**

鹿 **NX-820**

鹿 **NX-1232**

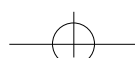

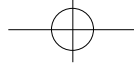

ELECTRONICS

PUBLICATION INFORMATION

SAMSUNG ELECTRONICS Co.

reserves the right to revise information in this publication for any reason without prior notice.

SAMSUNG ELECTRONICS Co.

also reserves the right to make changes in equipment design or components as engineering and manufacturing may warrant without prior notice .

COPYRIGHT 1997 SAMSUNG ELECTRONICS Co.

All rights reserved. No part of this manual may be reproduced in any form or by any means --- graphic, electronic or mechanical, including recording, taping, photocopying or information retrieval systems --- without express written permission of the publisher of this material.

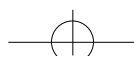



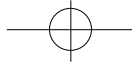

NX-SERIES

NX-308 NX-820 NX-1232

**ELECTRONIC KEY/HYBRID
TELEPHONE SYSTEM**

TECHNICAL MANUAL

INCLUDES :

**GENERAL DESCRIPTION SECTION
INSTALLATION SECTION
FEATURE SECTION
PROGRAMMING SECTION
APPENDIX SECTION
BACK-UP DATA SHEETS**

General Description

Installation

Features

Programming

Appendix

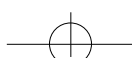

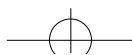
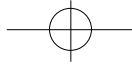

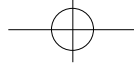

GENERAL DESCRIPTION SECTION

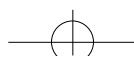



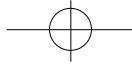

TABLE OF CONTENTS

GENERAL DESCRIPTION

General Description

NX-SERIES GENERAL SYSTEM DIAGRAM 1-1

1. SYSTEM OVERVIEW 1-2

 1.1 NX-308 SYSTEM 1-2

 1.2 NX-820 SYSTEM 1-2

 1.3 NX-1232 SYSTEM 1-2

2. NX-SERIES LAYOUT 1-3

 2.1 TOP VIEW 1-3

 2.2 SIDE VIEW 1-3

3. SYSTEM CONFIGURATION 1-4

 3.1 NX-308 SYSTEM 1-4

 3.2 NX-820 SYSTEM 1-4

 3.3 NX-1232 SYSTEM 1-5

4. HARDWARE DESCRIPTION 1-6

 4.1 KSU (Key Service Unit) 1-6

 4.2 EXPANSION CARDS & OPTION BOARDS 1-6

 4.3 STATION EQUIPMENT 1-7

5. SPECIFICATIONS 1-8

 5.1 ELECTRICAL SPECIFICATIONS 1-8

 5.2 DIMENSIONS AND WEIGHTS 1-8

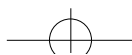



NX-SERIES HYBRID KEY SYSTEM

GENERAL DESCRIPTION SECTION

5.3 ENVIRONMENTAL LIMITATIONS 1-8
5.4 CABLE REQUIREMENTS 1-8
5.5 SYSTEM TONES AND RINGS 1-9
5.6 KEYSER LED INDICATIONS 1-10

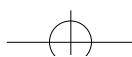

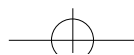
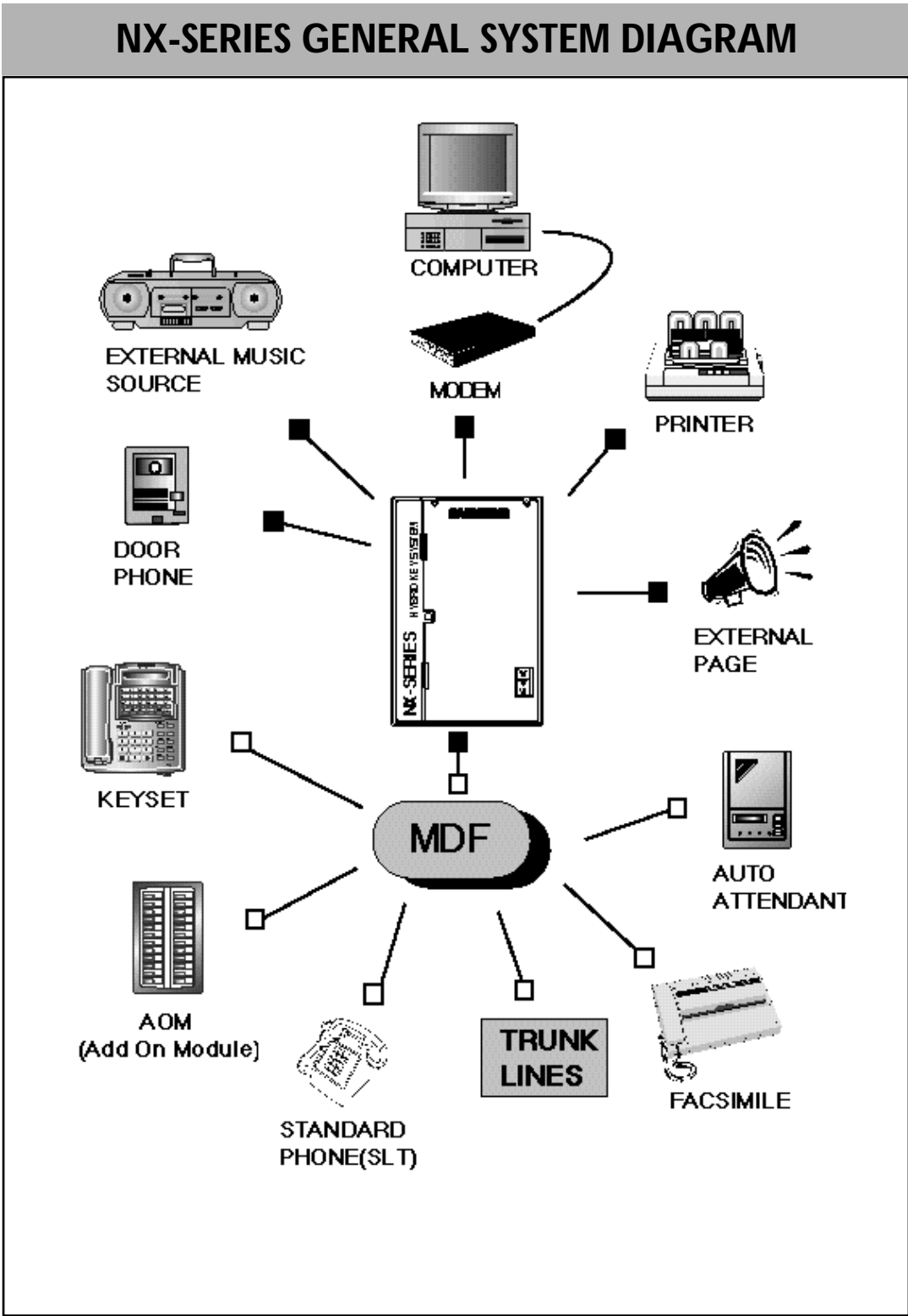
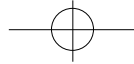

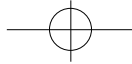

1. SYSTEM OVERVIEW

The **NX-series** hybrid key system accommodates three kinds of Key Station: **NX-308**, **NX-820** and **NX-1232**.

1.1 NX-308 SYSTEM

The **NX-308**, with a maximum capacity of **three telephone C.O. lines** and **eight stations**, is an analog telephone system designed for the small-sized business. A powerful **HM64180R1** digital microprocessor controls all speech paths and system functions. The operating program with default memory is stored in non-volatile ROM **27C020**. Customer data is stored in RAM **62256** and is protected for up to seven continuous days' loss of system power by a Ni-Cd battery. When AC power is restored, the Ni-Cd battery is recharged automatically.

1.2 NX-820 SYSTEM

Designed for small to medium-sized businesses, the **NX-820** is an analog telephone system featuring a maximum capacity of **forty (40) ports**, made up of the combined total of C.O. telephone lines and stations, permitting various configurations. Comprised of a Key Service Unit, expansion boards, electronic keysets and conventional single line telephones, the **NX-820** offers small or medium-sized business users flexible control of telephone communications. A powerful **HM64180R1** digital microprocessor controls all speech paths and system functions. The operating program with default memory is stored in non-volatile ROM **27C020**. Customer data is stored in RAM **681000**, and is protected for up to seven continuous days' loss of system power by a Ni-Cd battery. When AC power is restored, the Ni-Cd battery is recharged automatically.

1.3 NX-1232 SYSTEM

The **NX-1232** is an analog telephone system designed for small to medium-sized business. The **NX-1232** system has a maximum capacity of **forty eight (48) ports**, made up of the combined total of C.O. telephone lines and stations, permitting various configurations. Comprised of a Key Service Unit, expansion boards, electronic keysets and conventional single line telephones, the **NX-1232** system offers small or medium-sized business users flexible control of telephone communications. A powerful **HM64180R1** digital microprocessor controls all speech paths and system functions. The operating program with default memory is stored in non-volatile ROM **27C020**. Customer data is stored in RAM **681000**, and is protected for up to seven continuous days' loss of system power by a Ni-Cd battery. When AC power is restored, the Ni-Cd battery is recharged automatically.

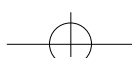

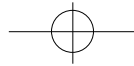

2. NX-SERIES LAYOUT

2.1 TOP VIEW

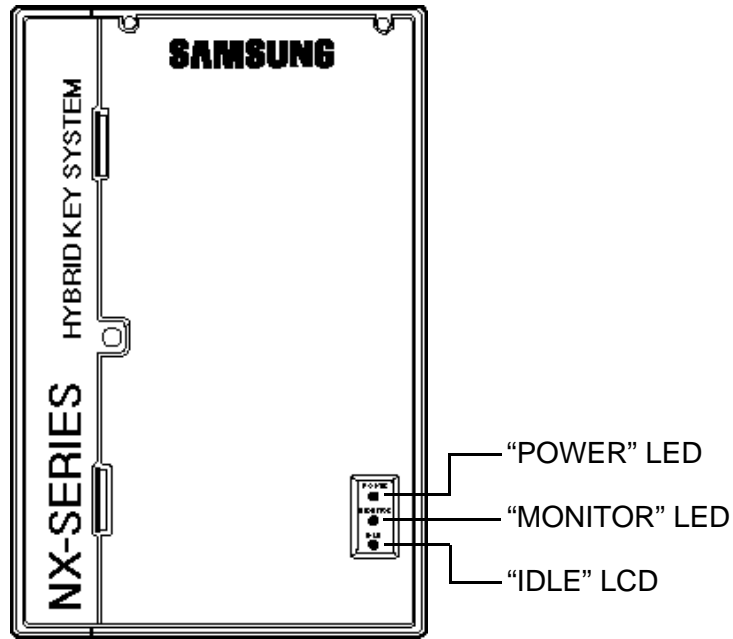

General Description

2.2 SIDE VIEW

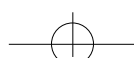
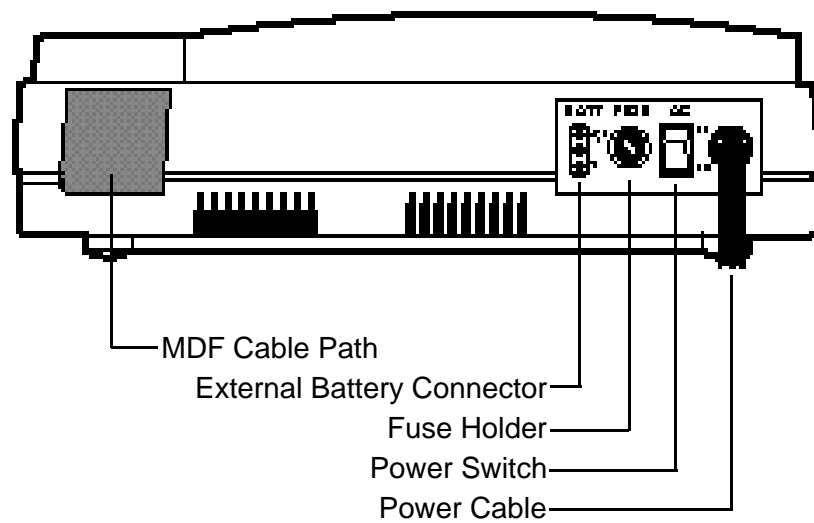

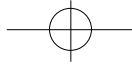

3. SYSTEM CONFIGURATION

3.1 NX-308 SYSTEM

The basic KSU (Key Service Unit) comes equipped to operate three telephone lines and eight stations. Station #1 is assigned to be used with a keyset and stations #2 through #8 are assigned as keysets or single-line telephones. The **NX-SMDR/R-MMC** board is the **SMDR** and **REMOTE MMC** serial interface, and the **NX-DPH/PAGING** board is the door phone and external paging interface. These optional boards can be installed on the base board

3.2 NX-820 SYSTEM

The basic KSU (Key Service Unit) comes equipped to operate four telephone lines and twelve stations. Stations #1 through #4 are assigned to be used with keysets and stations #5 through #12 are assigned for single-line telephones. The NX-820 system accomodates several kinds of expansion card. The **NX-2TRK**, **NX-4TRK**, **NX-4KLI**, **NX-4SLI**, **NX-4OPX**, **NX-8KLI** and **NX-8SLI** cards may be installed in any of the three expansion slots. By combining these cards, the **NX-820** system can be increased to its maximum capacity of forty ports. Optionally, the **NX-SMDR/R-MMC**, **NX-DPH/PAGING**, **NX-MPD** and **NX-PRS** board can be installed on the base board. The **NX-SMDR/R-MMC** board is the **SMDR** and **REMOTE MMC** serial interface, the **NX-DPH/PAGING** board is the door phone and external paging interface and the **NX-MPD**, **NX-PRS** board are interface for calculating call cost.

But, maximum keyphone part is restricted to **twenty four(24) ports** although **three NX-8KLI** cards are used.

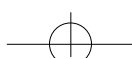
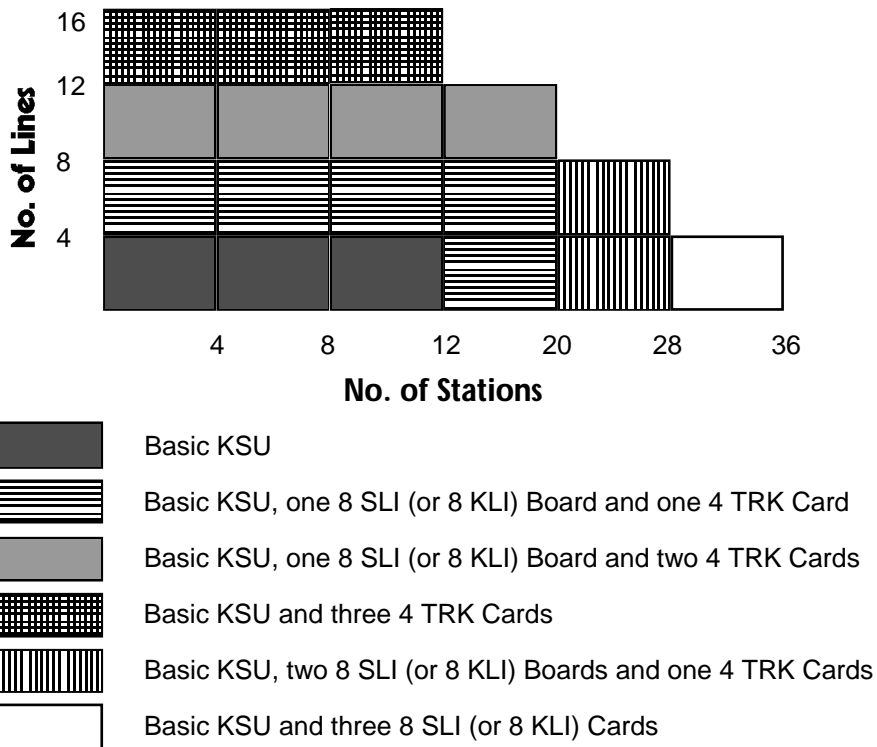

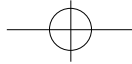

3.3 NX-1232 SYSTEM

The basic KSU (Key Service Unit) comes equipped to operate eight telephone lines and sixteen stations. Stations #1 through #8 are assigned to be used with keysets or single line telephones, and stations #9 through #16 are assigned for single line telephones. The **NX-1232** system accepts several kinds of expansion cards. The **NX-2TRK**, **NX-4TRK**, **NX-4KLI**, **NX-4SLI**, **NX-4OPX**, **NX-8KLI**, **NX-8SLI** cards can be installed in any of the three expansion slots. By combining these cards, the **NX-1232** system can be increased to its maximum capacity of **forty eight ports**.

Optionally, the **NX-SMDR/R-MMC**, **NX-DPH/PAGING**, **NX-MPD** and **NX-PRS** board can be installed on the base board. The **NX-SMDR/R-MMC** board is the **SMDR** and **REMOTE MMC** serial interface, the **NX-DPH/PAGING** board is the door phone and external paging interface and the **NX-MPD**, **NX-PRS** board are interface for calculating call cost.

But, maximum keyphone part is restricted to **twenty four(24) ports** although **three NX-8KLI** cards are used.

General Description

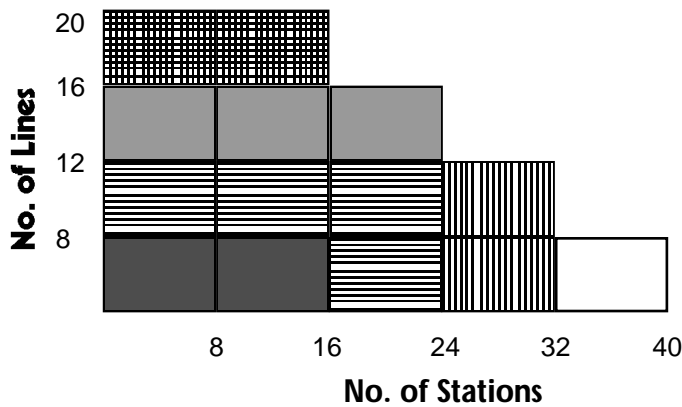

- Basic KSU
- Basic KSU, one 8 SLI (or 8 KLI) Board and one 4 TRK Card
- Basic KSU, one 8 SLI (or 8 KLI) Board and two 4 TRK Cards
- Basic KSU and three 4 TRK Cards
- Basic KSU, two 8 SLI (or 8 KLI) Board and one 4 TRK Card
- Basic KSU and three 8 SLI (or 8 KLI) Cards



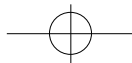

4. HARDWARE DESCRIPTION

4.1 KSU (Key Service Unit)

The KSU of the NX-series is a single cabinet, wall mounted, metal cased unit, containing the following:

Power Supply

Processing, switching, and customer memory for all ports.

Internal music source and External music interface

2 Power Failure Transfer

Back-up Battery for memory protection

Real Time Clock (RTC)

NX-308 SYSTEM	NX-820 SYSTEM	NX-1232 SYSTEM
3 Trunk interfaces 1 keyset, 7 Hybrid station interfaces	4 Trunk interfaces 4 KTS and 8 SLT station interfaces	8 Trunk interfaces 8 hybrid and 8 SLT station interfaces

4.2 EXPANSION CARDS & OPTION BOARDS

NX-2TRK card provides two loop start trunk interfaces.
can be installed **NX-820** and **NX-1232** system.

NX-4TRK card provides four loop start trunk interfaces.
can be installed **NX-820** and **NX-1232** system.

NX-4KLI card provides four ports for keysets.
can be installed **NX-820** and **NX-1232** system.

NX-4SLI card provides four SLI ports for industry standard single line telephones.
can be installed **NX-820** and **NX-1232** system.

NX-4OPX card provides four OPX line port for industry standard single line telephones and can be connected to PBX lines.
can be installed **NX-820** and **NX-1232** system.

NX-8KLI card provides eight ports for keysets.
can be installed **NX-820** and **NX-1232** system.

NX-8SLI card provides eight SLI port for industry standard single line telephones.
can be installed **NX-820** and **NX-1232** system.

NX-MPD board provides two ports for metering pulse detection.
can be installed **NX-820** and **NX-1232** system.

NX-PRS board provides two ports for polarity reverse signal detection.
can be installed **NX-820** and **NX-1232** system.

NX-SMDR/R-MMC board provides two serial ports for SMDR and REMOTE MMC.
can be installed all **NX-SERIES** system.

NX-DPH/PAGING board provides two DOOR PHONE interface and one EXTERNAL PAGING interface.
can be installed all **NX-SERIES** system.



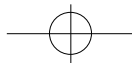

4.3 STATION EQUIPMENT

Keypad with 24 buttons (NX-24E, NX-24B)

- Built-in speakerphone
- 24 programmable soft keys (12 with tri-colored LEDs) and 10 fixed-function keys
- UP/DOWN buttons for digital control of speaker, handset, and ringer volumes.
- Four selectable ring tones per keypad
- Desk- or wall- mount
- NX-24E** keypad with 16 character display

Keypad with 12 buttons (NX-12E, NX-12B)

- Built-in speakerphone
- 12 programmable soft keys (6 with tri-colored LEDs) and 10 fixed-function keys
- UP/DOWN buttons for digital control of speaker, handset, and ringer volumes.
- Four selectable ring tones per keypad
- Desk- or wall- mount
- NX-12E** keypad with 16 character display

Basic keypad with 6 buttons (NX-6B)

- 6 programmable soft keys and 10 fixed-function keys
- UP/DOWN buttons for digital control of speaker, handset, and ringer volumes.
- Four selectable ring tones per keypad
- Desk- or wall- mount

Add On Module (NX-AOM)

- 24 programmable soft keys

General Description



NX-24E



NX-24B



NX-12E



NX-12B



NX-6B

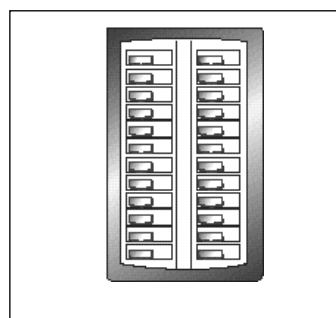

NX-AOM





5. SPECIFICATIONS

5.1 ELECTRICAL SPECIFICATIONS

AC INPUT	110/220 VAC, 50/60 Hz	
POWER CONSUMPTION	NX-308	50 WATTS MAX
	NX-820	55 WATTS MAX
	NX-1232	80 WATTS MAX
MAX CURRENT DRAW AT 220 VAC	NX-308	0.22 AMP
	NX-820	0.29 AMP
	NX-1232	0.36 AMP
RING GENERATOR	AC 80 Vrms, 25 Hz	
BATTERY BACKUP SUPPLY	24 VDC, 6 to 26Ah	

5.2 DIMENSIONS AND WEIGHTS

KEY SERVICE UNIT	NX-308	530mm(H) x 348mm(W) x 102mm(D), 4.9Kg
	NX-820	530mm(H) x 412mm(W) x 140mm(D), 8.9Kg
	NX-1232	530mm(H) x 412mm(W) x 140mm(D), 8.9Kg
KEYSET	214mm(H) x 206mm(W) x 150mm(D), 1.1Kg	
AOM	214mm(H) x 133mm(W) x 150mm(D), 0.4Kg	
DOOR PHONE	158mm(H) x 89mm(W) x 41mm(D), 0.23Kg	

5.3 ENVIRONMENTAL LIMITATIONS

OPERATING TEMPERATURES	0 - 45 (18 - 25 recommended)
OPERATING HUMIDITY	10% - 90% (non-condensing)

5.4 CABLE REQUIREMENTS









ELECTRONIC SET	2 pair twisted, Max. 400 m (24 AWG)
SINGLE LINE TELEPHONE	1 pair twisted, Max. 1 km (24 AWG)
DOOR PHONE	1 pair twisted, Max. 100 m (24 AWG)
4 OPX B'D	1 pair twisted, Max. 2Km (24 AWG)



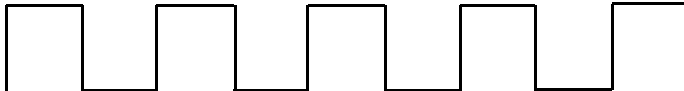

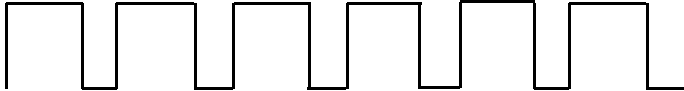
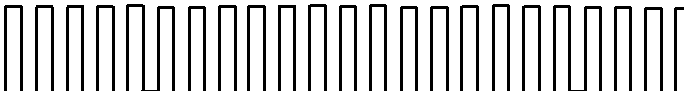
5.5 SYSTEM TONES AND RINGS

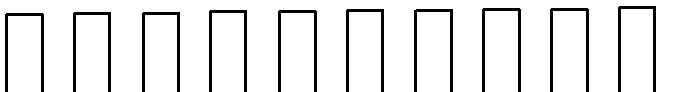
General Description

DIAL TONE : A steady tone that indicates dialing may begin		CONTINUOUS
RING-BACK TONE : Indicates the station dialed is ringing.		400 ON / 200 OFF / 400 ON / 3000 OFF
BUSY TONE : Indicates the station dialed is busy.		500 ON / 500 OFF / 500 ON / 500 OFF
TRANSFER TONE : Indicates a call is being held and you can dial another party.		200 ON / 200 OFF / 200 ON / 200 OFF
ERROR TONE : Indicates you have done something incorrectly.		500 ON / 250 OFF / 500 ON / 250 OFF
CONFIRMATION TONE : Indicates you have correctly set or canceled a system feature.		100 ON / 100 OFF / 100 ON / 100 OFF
INTRUSION TONE : Indicates you have been barged-in on.		200 ON / 200 OFF / 200 ON / 5000 OFF
MESSAGE WAITING TONE : Indicates messages on SLT type station.		1000 ON / 250 OFF / 1000 ON / 250 OFF
CAMP-ON REMINDER TONE : Indicates a call transfered to you while you are busy.		1000 ON / 15000 OFF / 1000 ON / 15000 OFF
CO LINE RING : Indicates an outside call is ringing on your station.		1000 ON / 3000 OFF / 1000 ON / 3000 OFF

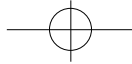

**NX-SERIES** HYBRID KEY SYSTEM

GENERAL DESCRIPTION SECTION

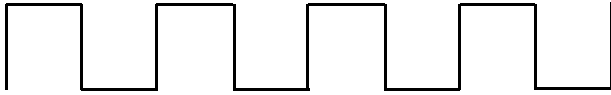
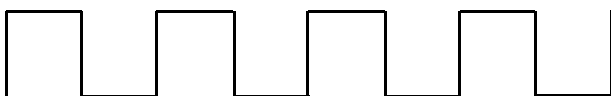
STATION RING: Indicates an intercom call is ringing on your station.	
	400 ON / 200 OFF / 400 ON / 3000 OFF
DOORPHONE RING: Indicates a doorphone call is ringing on your station.	
	500 ON / 500 OFF / 500 ON / 500 OFF
ALARM RING: Indicates an alarm is ringing on your station.	
	500 ON / 500 OFF / 500 ON / 500 OFF

NOTE : The details may vary according to the regulations or customers request.

5.6 KEYSSET LED INDICATIONS

CONDITION	LED COLOR	LED STATUS
LINE IDLE	—	OFF
LINE IN USE	RED or GREEN	STEADY ON
RECALL	AMBER	FAST FLASH
CALL ON HOLD	RED or GREEN	SLOW FLASH
RINGING C.O. CALL	RED or GREEN	FAST FLASH
RINGING INTERNAL CALL	GREEN	FAST FLASH
DND INDICATION	RED	STEADY ON

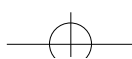

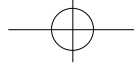

INSTALLATION SECTION

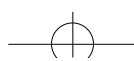

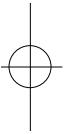

NX-SERIES HYBRID KEY SYSTEM

INSTALLATION SECTION

4 MDF CABLING	2-9
4.1 Clip type MDF Cabling	2-19
4.2 Using to Cable tie	2-19
5. CONNECTING TELEPHONE LINES	2-20
5.1 SAFETY PRECAUTIONS	2-20
5.2 LOOP START LINES	2-20
6. CONNECTING STATION EQUIPMENT	2-20
6.1 CONNECTING KEYSSET / AOM	2-20
6.1.1 NX-308 - Related Switch Location	2-20
6.1.2 NX-820	2-21
6.1.3 NX-1232 Related Switch Location	2-21
6.2 CONNECTING Single-Line Tel.	2-21
6.2.1 NX-308 - Related Switch Location	2-22
6.2.2 NX-820	2-22
6.2.3 NX-1232 - Related Switch Location	2-22
7. CONNECTING OPTIONAL EQUIPMENT	2-27
7.1 EXTERNAL MUSIC SOURCE	2-27
7.2 EXTERNAL PAGING FOR STANDARD	2-27
7.3 DOORPHONE AND DOOR LOCK RELEASE	2-28
7.4 SMDR / REMOTE PROGRAMMING	2-29
7.5 POWER FAILURE TRANSFER	2-31
7.5.1 NX-308 system	2-31
7.5.2 NX-820 system	2-31
7.5.3 NX-1232 system	2-31
7.6 EXTERNAL BATTERY	2-31
8. BEFORE POWER UP	2-32
9 INSTALLING TO KEYSSET	2-33
9-1 CONNECTING TO LINE CORD	2-33
9-2 WALL-MOUNTING A KEYSSET	2-33
9-3 HOW TO REMOVE THE HANDSET CORD FROM THE HANDSET	2-34

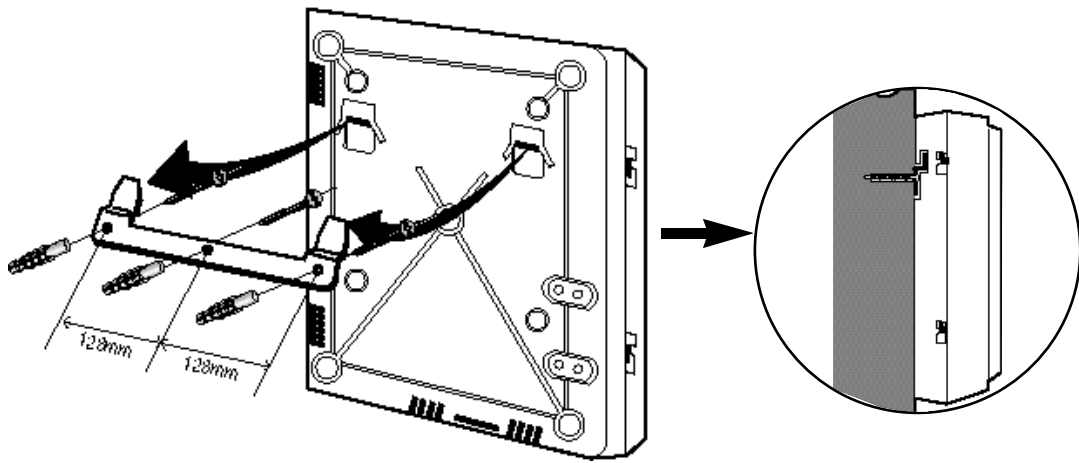

FIGURE 2-1 MOUNTING THE KSU

2.3 AC Power Selection (See FIGURE 2-2)

Before plugging in the KSU, set the AC power selection connector. The Power board of each system has three power connectors. One is for 0V (Ground) and the rest are for 110V/220V selection. The KSU has two lines; one black and the other sky-blue (or white); with a pink power connection jack. Verify the AC voltage and connect the sky-blue (or white) line to the 0V connector, and black to the AC power connector.

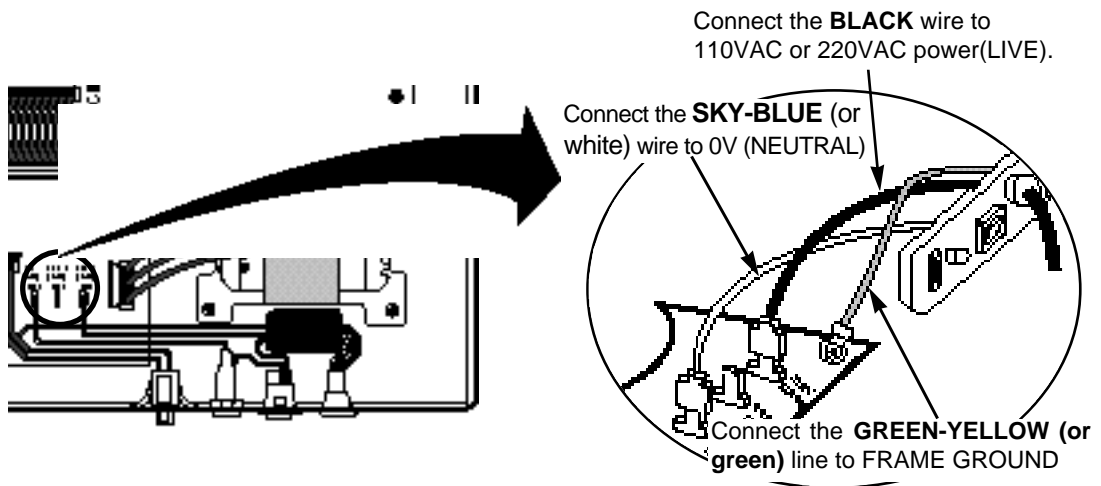

FIGURE 2-2 AC POWER SELECTION

3. INSTALLATION EXPANSION CARDS & OPTION BOARDS

Unpack and inspect each card before installing. Check for signs of physical damage. If any damage is detected, do not attempt to install.

3.1 NX-2TRK Card (See FIGURE 3 - 1)

Insert the NX-2TRK Card into any expansion slot. Push firmly to ensure that it is fully inserted into the backplane connector.

3.2 NX-4TRK Card (See FIGURE 3 - 1)

Insert the NX-4TRK Card into any expansion slot. Push firmly to ensure that it is fully inserted into the backplane connector.

3.3 NX-4KLI Card (See FIGURE 3 - 2)

Insert the NX-4KLI Card into any expansion slot. Push firmly to ensure that it is fully inserted into the backplane connector.

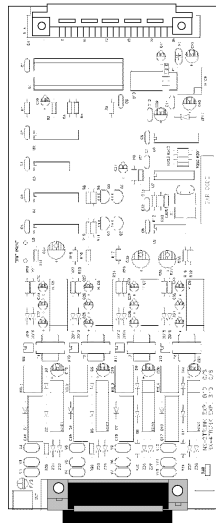

FIGURE 3-1 NX-2/4 TRK CARD

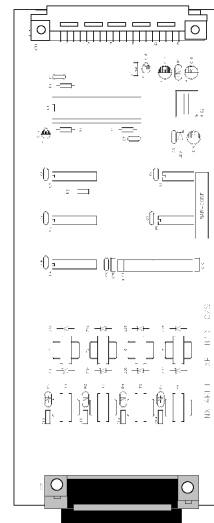

FIGURE 3-2 NX-4KLI CARD

3.4 NX-4SLI Card (See FIGURE 3 - 3)

Insert the NX-4SLI Card into any expansion slot. Push firmly to ensure that it is fully inserted into the backplane connector.

3.5 NX-4OPX Card (See FIGURE 3 - 4)

Insert the NX-4OPX Card into any expansion slot. Push firmly to ensure that it is fully inserted into the backplane connector.

3.8 NX-SMDR/R-MMC Board (See FIGURE 3 - 7)

Install the NX-SMDR/R-MMC board on the bottom of the base board.

3.9 NX-DPH/PAGING Board (See FIGURE 3 - 8)

Install the NX-DPH/PAGING board on the middle of the base board.

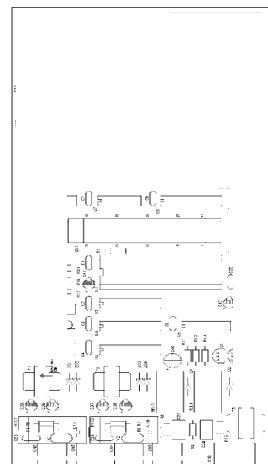
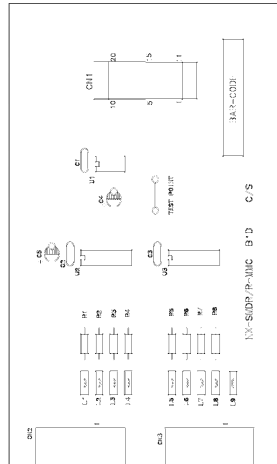

FIGURE 3-7 NX-SMDR/R-MMC BOARD

FIGURE 3-8 NX-DPH/PAGING BOARD

3.10 NX-MPD Board (See FIGURE 3 - 9)

Install the NX-MPD board on the bottom of the base board.

3.11 NX-PRS Board (See FIGURE 3 - 10)

Install the NX-PRS board on the bottom of the base board.

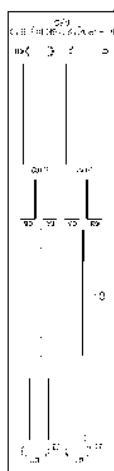

FIGURE 3-9 NX-MPD BOARD

FIGURE 3-10 NX-PRS BOARD

3.13.2 NX-820 SYSTEM (See FIGURE 3-13)

NX-820 system can have up to three expansion cards under the base board. And NX-SMDR/R-MMC, NX-DPH/PAGING, NX-MPD and NX-PRS option boards are installed on the surface of Base board.

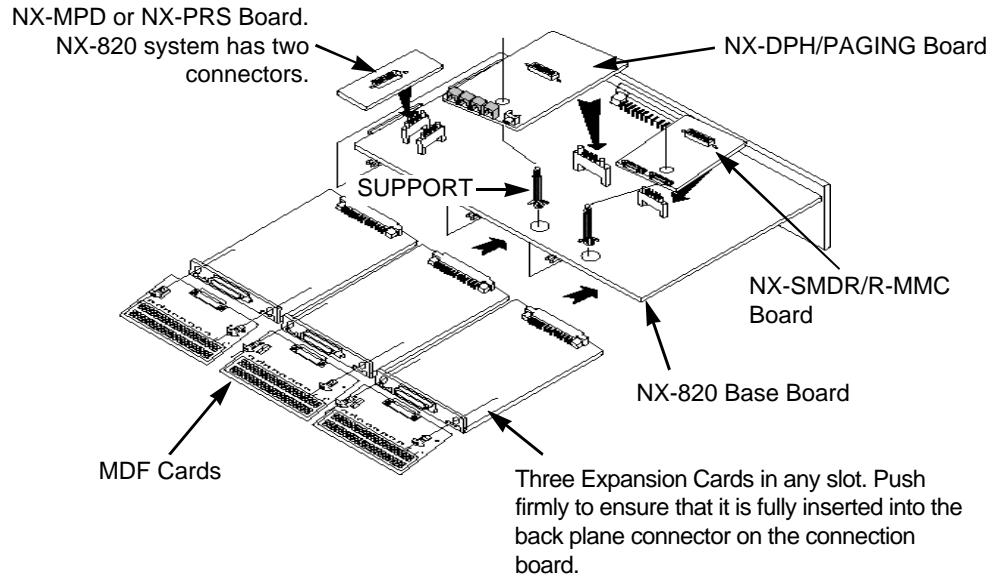

FIGURE 3-13 INSTALLING EXPANSION CARD & OPTION B'D FOR NX-820

3.13.3 NX-1232 SYSTEM (See FIGURE 3-14)

NX-1232 system can have up to three expansion cards under the base board. And NX-SMDR/R-MMC, NX-DPH/PAGING, NX-MPD and NX-PRS option boards are installed on the surface of Base board.

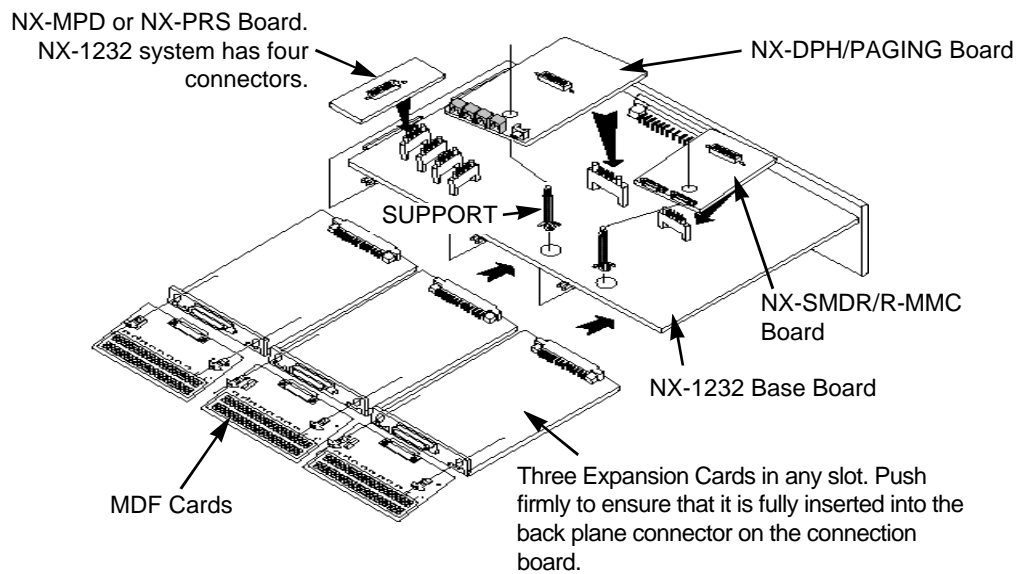
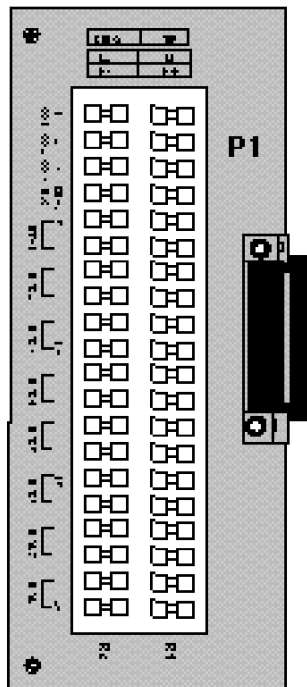

FIGURE 3-14 INSTALLING EXPANSION CARD & OPTION B'D FOR NX-1232

NX-SERIES HYBRID KEY SYSTEM

INSTALLATION SECTION



50 PIN CHAMP CONNECTOR		P1	
PIN NO.	COLOR	MDFA-C	FUNCTION
1	BL-W	R1 1	C.O.1 TIP
26	W-BL	R2 1	RING
2	O-W	R1 2	C.O.2 TIP
27	W-O	R2 2	RING
3	GN-W	R1 3	C.O.3 TIP
28	W-GN	R2 3	RING
4	BR-W	R1 4	RESERVED
29	W-BR	R2 4	
5	S-W	X	NC
30	W-S		
6	BL-R	R1 5	STN1 L1
31	R-BL	R2 5	L2
7	O-R	R1 6	STN1 D+
32	R-O	R2 6	D-
8	GR-R	R1 7	STN2 L1
33	R-GR	R2 7	L2
9	BR-R	R1 8	STN2 D+
34	R-BR	R2 8	D-
10	S-R	R1 9	STN3 L1
35	R-S	R2 9	L2
11	BL-BK	R1 10	STN3 D+
36	BK-BL	R2 10	D-
12	O-BK	R1 11	STN4 L1
37	BK-O	R2 11	L2
13	GR-BK	R1 12	STN4 D+
38	BK-GR	R2 12	D-
14	BR-BK	R1 13	STN5 L1
39	BK-BR	R2 13	L2
15	S-BK	R1 14	STN5 D+
40	BK-S	R2 14	D-
16	BL-Y	R1 15	STN6 L1
41	Y-BL	R2 15	L2
17	S-Y	R1 16	STN6 D+
42	Y-S	R2 16	D-
18	GR-Y	R1 17	STN7 L1
43	Y-GR	R2 17	L2
19	BR-Y	R1 18	STN7 D+
44	Y-BR	R2 18	D-
20	S-Y	R1 19	STN8 L1
45	Y-S	R2 19	L2
21	BL-VL	R1 20	STN8 D+
46	VL-BL	R2 20	D-
22	O-VL	X	NC
47	VL-O		
23	GR-VL	X	NC
48	VL-GR		
24	BR-VL	X	NC
49	VL-BR		
25	S-VL	X	NC
50	VL-S		

FIGURE 4-1 MDFA-C CONNECTIONS FOR NX-308

NX-SERIES HYBRID KEY SYSTEM

INSTALLATION SECTION

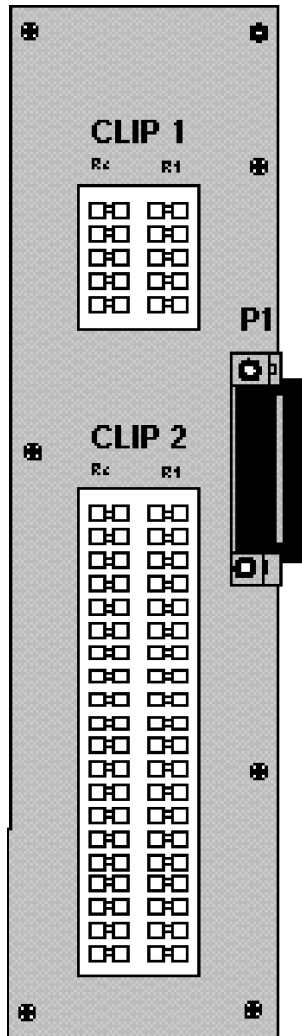

50 PIN CHAMP		P1		CLIP
PIN NO.	COLOR	MDFB-C	FUNCTION	
1	BL-W	R1 1	C.O.1 TIP	CLIP 1
26	W-BL	R2 1	RING	
2	O-W	R1 2	C.O.2 TIP	
27	W-O	R2 2	RING	
3	GN-W	R1 3	C.O.3 TIP	
28	W-GN	R2 3	RING	
4	BR-W	R1 4	C.O.4 TIP	CLIP 2
29	W-BR	R2 4	RING	
5	S-W	X	NC	
30	W-S			
6	BL-R	R1 1	STN1 L1	
31	R-BL	R2 1	L2	
7	O-R	R1 2	STN1 D+	
32	R-O	R2 2	D-	
8	GR-R	R1 3	STN2 L1	
33	R-GR	R2 3	L2	
9	BR-R	R1 4	STN2 D+	
34	R-BR	R2 4	D-	
10	S-R	R1 5	STN3 L1	
35	R-S	R2 5	L2	
11	BL-BK	R1 6	STN3 D+	
36	BK-BL	R2 6	D-	
12	O-BK	R1 7	STN4 L1	
37	BK-O	R2 7	L2	
13	GR-BK	R1 8	STN4 D+	
38	BK-GR	R2 8	D-	
14	BR-BK	R1 9	STN5 L1	
39	BK-BR	R2 9	L2	
15	S-BK	R1 10	STN5 D+	
40	BK-S	R2 10	D-	
16	BL-Y	R1 11	STN6 L1	
41	Y-BL	R2 11	L2	
17	S-Y	R1 12	STN6 D+	
42	Y-S	R2 12	D-	
18	GR-Y	R1 13	STN7 L1	
43	Y-GR	R2 13	L2	
19	BR-Y	R1 14	STN7 D+	
44	Y-BR	R2 14	D-	
20	S-Y	R1 15	STN8 L1	
45	Y-S	R2 15	L2	
21	BL-VL	R1 16	STN8 D+	
46	VL-BL	R2 16	D-	
22	O-VL	R1 17	STN9 L1	
47	VL-O	R2 17	L2	
23	GR-VL	R1 18	STN10 L1	
48	VL-GR	R2 18	L2	
24	BR-VL	R1 19	STN11 L1	
49	VL-BR	R2 19	L2	
25	S-VL	R1 20	STN12 L1	
50	VL-S	R2 20	L2	

FIGURE 4-3 MDFB-C CONNECTIONS FOR NX-820

NX-SERIES HYBRID KEY SYSTEM

INSTALLATION SECTION

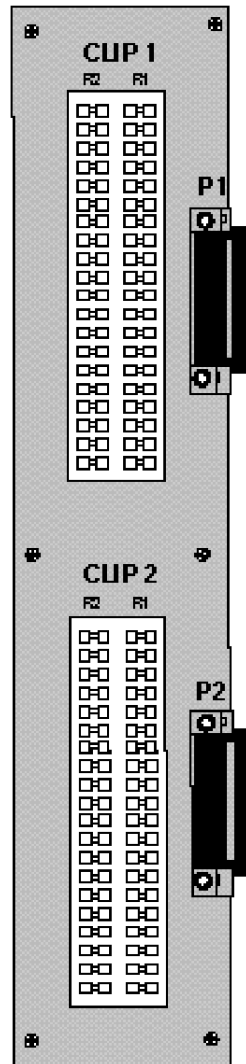

50 PIN CHAMP		P1		P2	
PIN NO.	COLOR	CLIP 1	FUNCTION	CLIP 2	FUNCTION
1	BL-W	R1 1	C.O.1 TIP	R1 1	STN5 L1
26	W-BL	R2 1	RING	R2 1	L2
2	O-W	R1 2	C.O.2 TIP	R1 2	STN5 D+
27	W-O	R2 2	RING	R2 2	D-
3	GN-W	R1 3	C.O.3 TIP	R1 3	STN6 L1
28	W-GN	R2 3	RING	R2 3	L2
4	BR-W	R1 4	C.O.4 TIP	R1 4	STN6 D+
29	W-BR	R2 4	RING	R2 4	D-
5	S-W	R1 5	C.O.5 TIP	R1 5	STN7 L1
30	W-S	R2 5	RING	R2 5	L2
6	BL-R	R1 6	C.O.6 TIP	R1 6	STN7 D+
31	R-BL	R2 6	RING	R2 6	D-
7	O-R	R1 7	C.O.7 TIP	R1 7	STN8 L1
32	R-O	R2 7	RING	R2 7	L2
8	GR-R	R1 8	C.O.8 TIP	R1 8	STN8 D+
33	R-GR	R2 8	RING	R2 8	D-
9	BR-R	R1 9	NC	R1 9	NC
34	R-BR	R2 9		R2 9	
10	S-R	R1 10	NC	R1 10	NC
35	R-S	R2 10		R2 10	
11	BL-BK	R1 11	NC	R1 11	NC
36	BK-BL	R2 11		R2 11	
12	O-BK	R1 12	NC	R1 12	NC
37	BK-O	R2 12		R2 12	
13	GR-BK	R1 13	STN1 L1	R1 13	STN9 L1
38	BK-GR	R2 13	L2	R2 13	L2
14	BR-BK	R1 14	STN1 D+	R1 14	STN10 L1
39	BK-BR	R2 14	D-	R2 14	L2
15	S-BK	R1 15	STN2 L1	R1 15	STN11 L1
40	BK-S	R2 15	L2	R2 15	L2
16	BL-Y	R1 16	STN2 D+	R1 16	STN12 L1
41	Y-BL	R2 16	D-	R2 16	L2
17	S-Y	R1 17	STN3 L1	R1 17	STN13 L1
42	Y-S	R2 17	L2	R2 17	L2
18	GR-Y	R1 18	STN3 D+	R1 18	STN14 L1
43	Y-GR	R2 18	D-	R2 18	L2
19	BR-Y	R1 19	STN4 L1	R1 19	STN15 L1
44	Y-BR	R2 19	L2	R2 19	L2
20	S-Y	R1 20	STN4 D+	R1 20	STN16 L1
45	Y-S	R2 20	D-	R2 20	L2
21	BL-VL	X	NC	X	NC
46	VL-BL				
22	O-VL	X	"	X	"
47	VL-O				
23	GR-VL	X	"	X	"
48	VL-GR				
24	BR-VL	X	"	X	"
49	VL-BR				
25	S-VL	X	"	X	"
50	VL-S				

FIGURE 4-5 MDFC-C CONNECTIONS FOR NX-1232

NX-SERIES HYBRID KEY SYSTEM

INSTALLATION SECTION

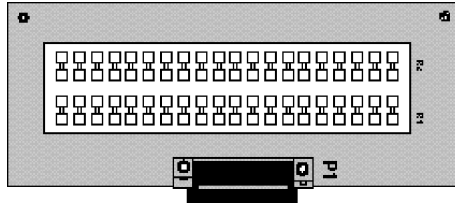

50 PIN CHAMP			2 TRK	4TRK	4KLI	4 SLI	8 KLI	8 SLI	4 OPX
PIN NO.	COLOR	MDFD-M	FUNCTION	FUNCTION	FUNCTION	FUNCTION	FUNCTION	FUNCTION	FUNCTION
1 26	BL-W W-BL	R1 1 R2 1	C.O.1 TIP RING	C.O.1 TIP RING	STN1 L1 L2	STN1 L1 L2	STN1 L1 L2	STN1 L1 L2	STN1 L1 L2
2 27	O-W W-O	R1 2 R2 2	RESERVED	RESERVED	STN1 D+ D-	RESERVED	STN1 D+ D-	RESERVED	RESERVED
3 28	GN-W W-GN	R1 3 R2 3	C.O.2 TIP RING	C.O.2 TIP RING	STN2 L1 L2	STN2 L1 L2	STN2 L1 L2	STN2 L1 L2	STN2 L1 L2
4 29	BR-W W-BR	R1 4 R2 4	RESERVED	RESERVED	STN2 D+ D-	RESERVED	STN2 D+ D-	RESERVED	RESERVED
5 30	S-W W-S	R1 5 R2 5	"	C.O.3 TIP RING	STN3 L1 L2	STN3 L1 L2	STN3 L1 L2	STN3 L1 L2	STN3 L1 L2
6 31	BL-R R-BL	R1 6 R2 6	"	RESERVED	STN3 D+ D-	RESERVED	STN3 D+ D-	RESERVED	RESERVED
7 32	O-R R-O	R1 7 R2 7	"	C.O.4 TIP RING	STN4 L1 L2	STN4 L1 L2	STN4 L1 L2	STN4 L1 L2	STN4 L1 L2
8 33	GR-R R-GR	R1 8 R2 8	"	RESERVED	STN4 D+ D-	RESERVED	STN4 D+ D-	RESERVED	RESERVED
9 34	BR-R R-BR	R1 9 R2 9	"	"	RESERVED	"	STN5 L1 L2	STN5 L1 L2	"
10 35	S-R R-S	R1 10 R2 10	"	"	"	"	STN5 D+ D-	RESERVED	"
11 36	BL-BK BK-BL	R1 11 R2 11	"	"	"	"	STN6 L1 L2	STN6 L1 L2	"
12 37	O-BK BK-O	R1 12 R2 12	"	"	"	"	STN6 D+ D-	RESERVED	"
13 38	GR-BK BK-GR	R1 13 R2 13	"	"	"	"	STN7 L1 L2	STN7 L1 L2	"
14 39	BR-BK BK-BR	R1 14 R2 14	"	"	"	"	STN7 D+ D-	RESERVED	"
15 40	S-BK BK-S	R1 15 R2 15	"	"	"	"	STN8 L1 L2	STN8 L1 L2	"
16 41	BL-Y Y-BL	R1 16 R2 16	"	"	"	"	STN8 D+ D-	RESERVED	"
17 42	S-Y Y-S	X	NC	NC	NC	NC	NC	NC	NC
18 43	GR-Y Y-GR	X	"	"	"	"	"	"	"
19 44	BR-Y Y-BR	X	"	"	"	"	"	"	"
20 45	S-Y Y-S	X	"	"	"	"	"	"	"
21 46	BL-VL VL-BL	X	"	"	"	"	"	"	"
22 47	O-VL VL-O	X	"	"	"	"	"	"	"
23 48	GR-VL VL-GR	X	"	"	"	"	"	"	"
24 49	BR-VL VL-BR	X	"	"	"	"	"	"	"
25 50	S-VL VL-S	X	"	"	"	"	"	"	"

FIGURE 4-7 MDFD-C CONNECTIONS(EXPANSION CARD)

NX-SERIES HYBRID KEY SYSTEM

INSTALLATION SECTION

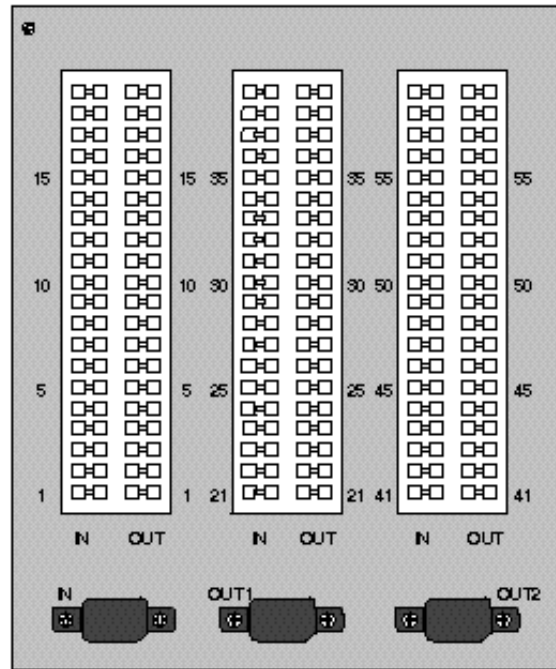

MDF Pin No.	Champ Pin No.	MDF Pin No.	Champ Pin No.	MDF Pin No.	Champ Pin No.
1	26	21	36	41	46
2	1	22	11	42	21
3	27	23	37	43	47
4	2	24	12	44	22
5	28	25	38	45	48
6	3	26	13	46	23
7	29	27	39	47	49
8	4	28	14	48	24
9	30	29	40	49	50
10	5	30	15	50	25
11	31	31	41	51	RESERVED
12	6	32	16	52	RESERVED
13	32	33	42	53	RESERVED
14	7	34	17	54	RESERVED
15	33	35	43	55	RESERVED
16	8	36	18	56	RESERVED
17	34	37	44	57	RESERVED
18	9	38	19	58	RESERVED
19	35	39	45	59	RESERVED
20	10	40	20	60	RESERVED

FIGURE 4-9 OPTIONAL MDF

5. CONNECTING TELEPHONE LINES

5.1 SAFETY PRECAUTIONS

To limit the risk of personal injury, always follow these precautions before connecting to TELCO circuits:

Never install telephone wiring during a lightning storm.

Never install telephone jacks in a wet location unless the jack is specifically designed for wet locations.

Never touch uninsulated telephone wires or terminals unless the telephone line has been disconnected at the network interface.

Use caution when installing or modifying telephone lines.

5.2 LOOP START LINES

Using one pair twisted #24 AWG or #26 AWG jumper wire, cross-connect each loop start C.O. line to the trunk port.

Refer to FIGURE 4-1 through 4-7 and 4-8.

6. CONNECTING STATION EQUIPMENT

Using one pair twisted #24 AWG or #26 AWG jumper wire, cross-connect each keyset/AOM or single-line telephone to the keyset port or SLI port of your choice.

6.1 CONNECTING KEYSET / AOM (FIGURE 6-1)

The NX-308 system has seven hybrid ports and the NX-1232 system has eight hybrid ports. Either a keyset or a single-line telephone may be connected to a hybrid port. Before connecting station equipment to a hybrid port, the switches on the Base Board must be set to keyset or SLT.

Each switch is composed of four sections, set to ON/ON/OFF/OFF to connect a keyset to the hybrid port.

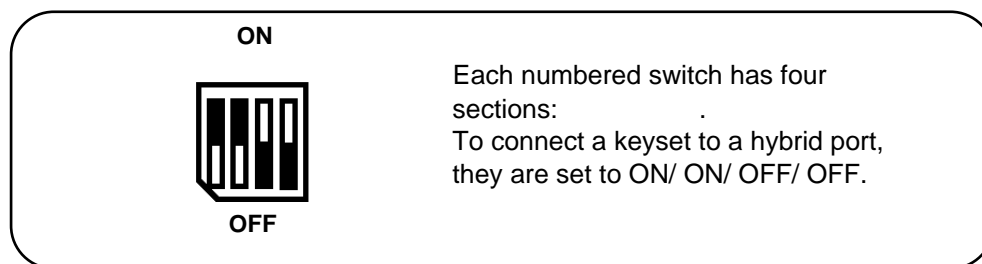

6.1.1 NX-308 - Related Switch Location (FIGURE 6-3)

To connect a keyset or AOM to station #2 to #8 of basic KSU, the related DIP switches should be set as follows: (Station #1 is a keyset-only station.)

6.2.1 NX-308 - Related Switch Location (FIGURE 6-3)

To connect the single line telephone to the any station from #2 to #8 of basic KSU, the related DIP switches should be set as follows.

Station No.		Releated DIP Switches				Setting
STN 2	SW 1	OFF	OFF	ON	ON	S
STN 3	SW 2	OFF	OFF	ON	ON	
STN 4	SW 3	OFF	OFF	ON	ON	
STN 5	SW 4	OFF	OFF	ON	ON	
STN 6	SW 5	OFF	OFF	ON	ON	
STN 7	SW 6	OFF	OFF	ON	ON	
STN 8	SW 7	OFF	OFF	ON	ON	

6.2.2 NX-820

To connect a single-line telephone to the from #5 to #12 of basic KSU.

6.2.3 NX-1232 - Related Switch Location (FIGURE 6-5)

To connect a single line telephone to any station from #1 to #16 of basic KSU.

Station No.		Releated DIP Switches				Setting
STN 1	SW 8	OFF	OFF	ON	ON	S
STN 2	SW 7	OFF	OFF	ON	ON	
STN 3	SW 6	OFF	OFF	ON	ON	
STN 4	SW 5	OFF	OFF	ON	ON	
STN 5	SW 4	OFF	OFF	ON	ON	
STN 6	SW 3	OFF	OFF	ON	ON	
STN 7	SW 2	OFF	OFF	ON	ON	
STN 8	SW 1	OFF	OFF	ON	ON	

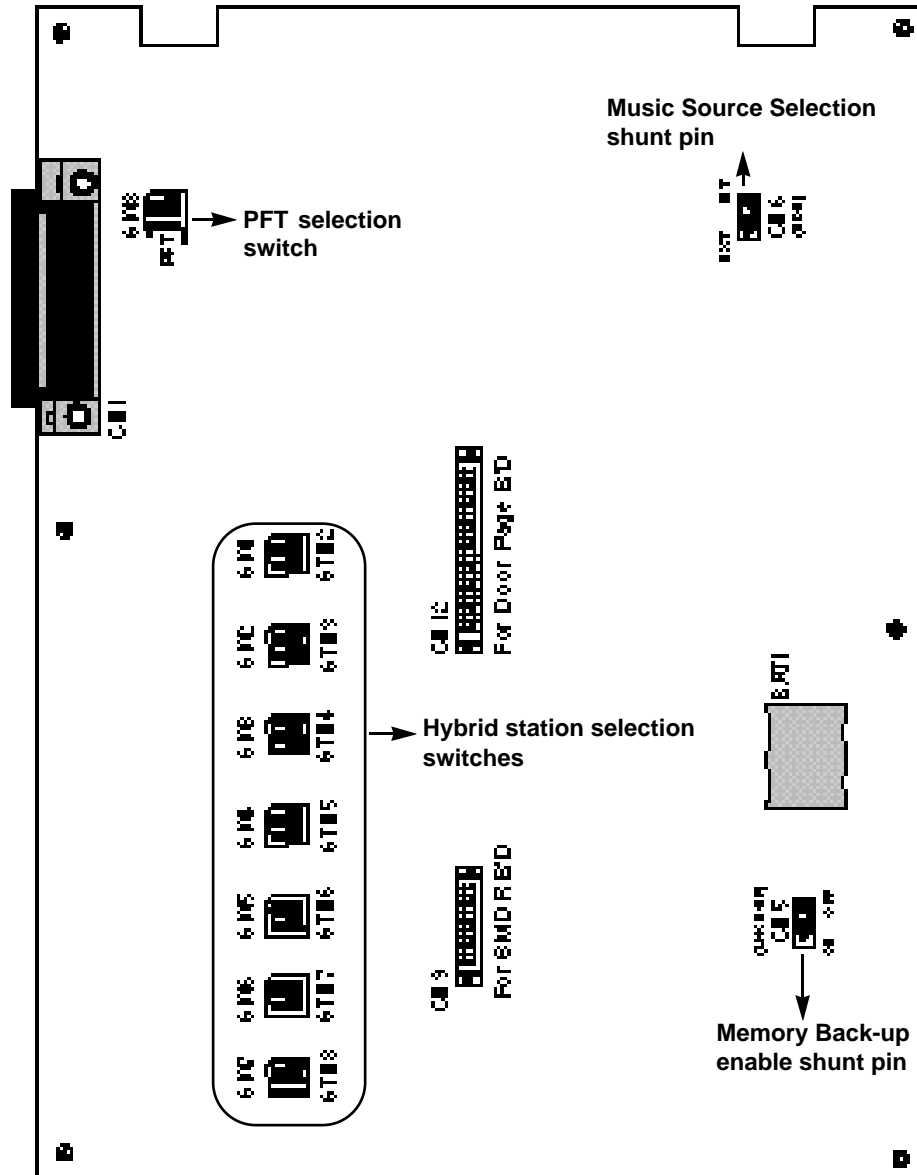

鹿 Hybrid Station Configuration



FIGURE 6-3 NX-308 KSU SWITCH LOCATIONS

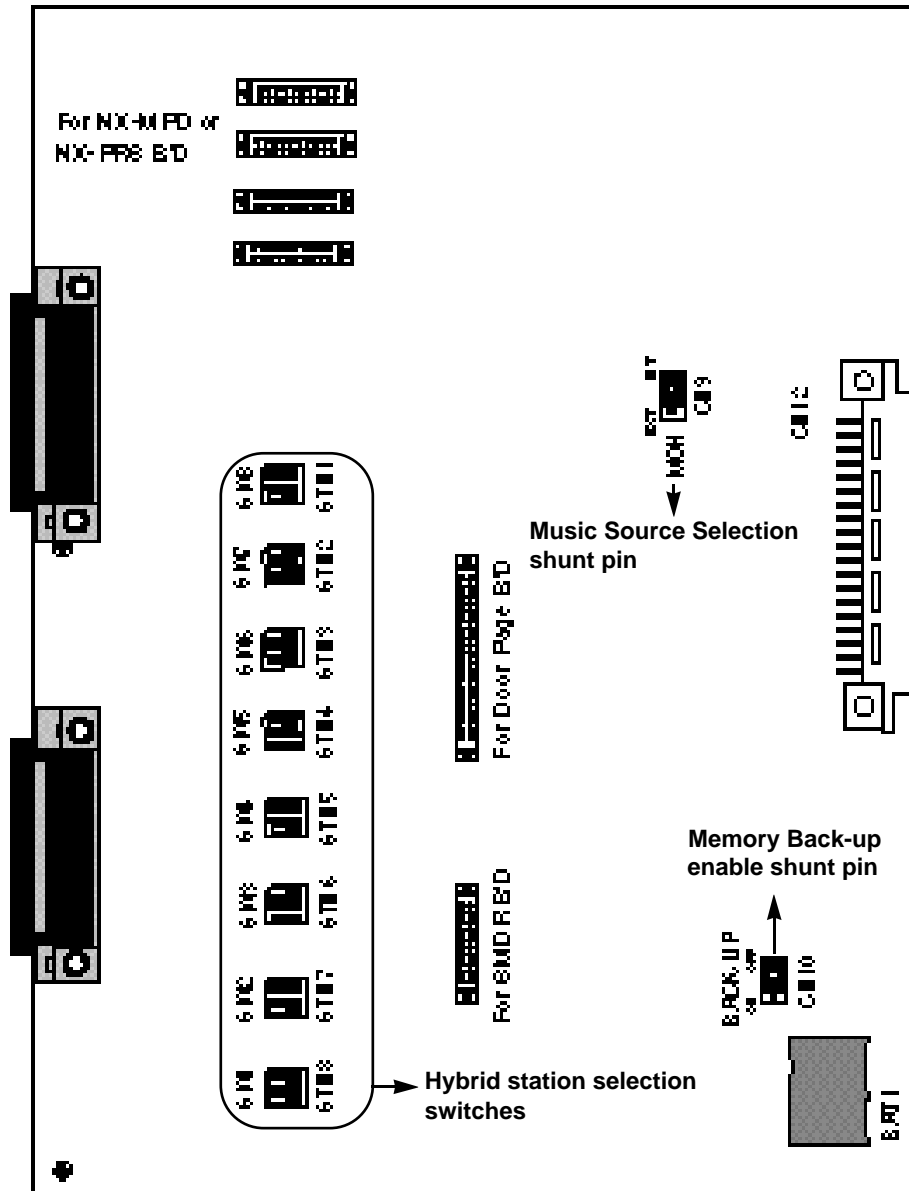

Hybrid Station Configuration



FIGURE 6-5 NX-1232 KSU SWITCH LOCATIONS

7.3 DOORPHONE AND DOOR LOCK RELEASE (See FIGURE 7-3)

System users have the capability of communicating with an optional door phone when the **NX-DPH/PAGING** board is installed. A maximum of two door phones may be installed per system.

To connect the door phone, plug a two-pair modular cable into the connector on the **KSU** marked **DOOR1** or **DOOR2**.

To connect the customer-provided electric door lock unit for control of the door lock release mechanism, plug a one-pair modular cable into the connector on the **KSU** marked **LOCKER1** or **LOCKER2**.

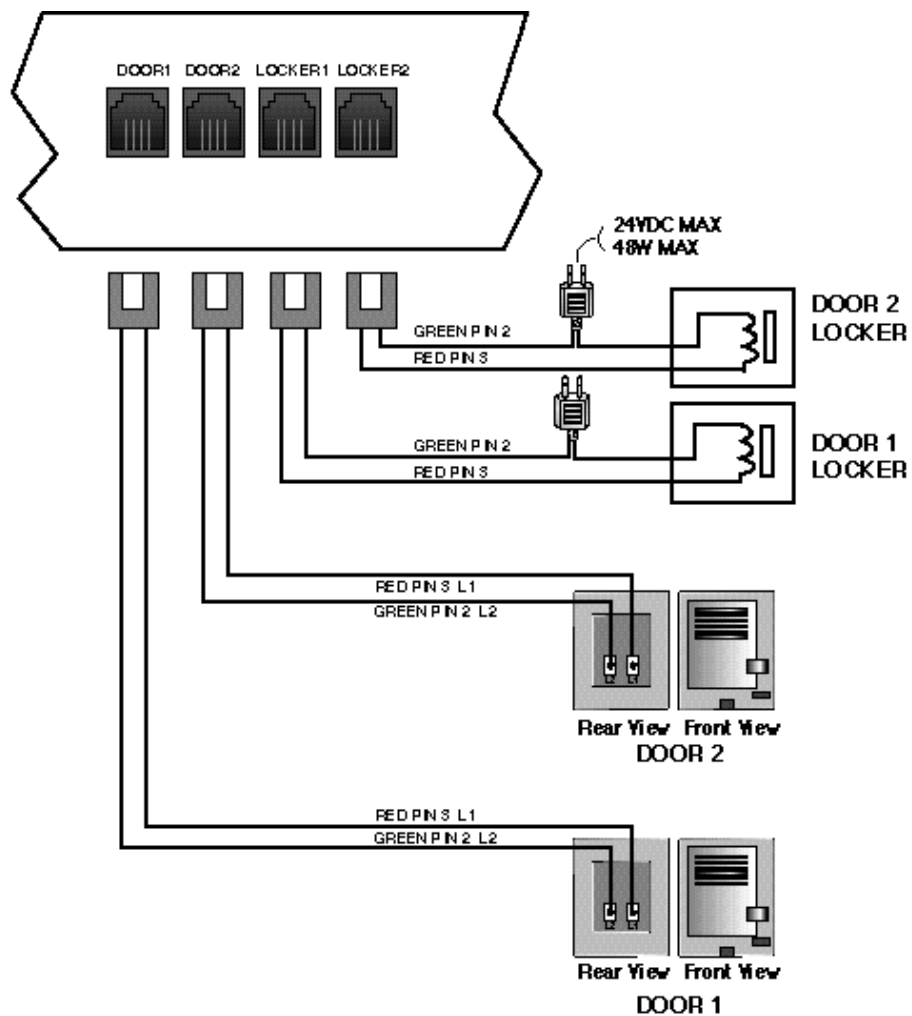
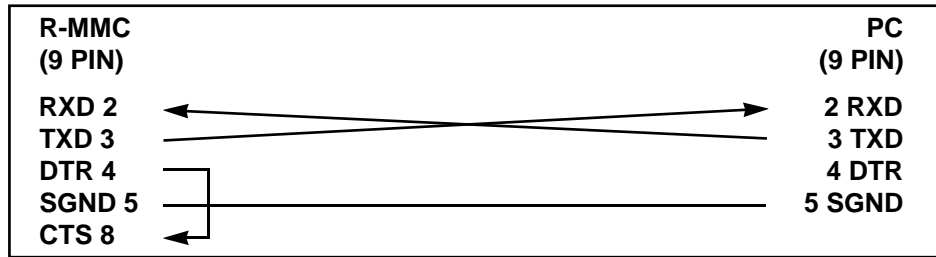

FIGURE 7-3 CONNECTING DOOR PHONE & DOOR LOCK RELEASE

NX-SERIES HYBRID KEY SYSTEM

INSTALLATION SECTION



NOTE : If the CTS pin is not connected, the system cannot check the printer (MODEM) status (power ON/OFF, paper empty, etc.)

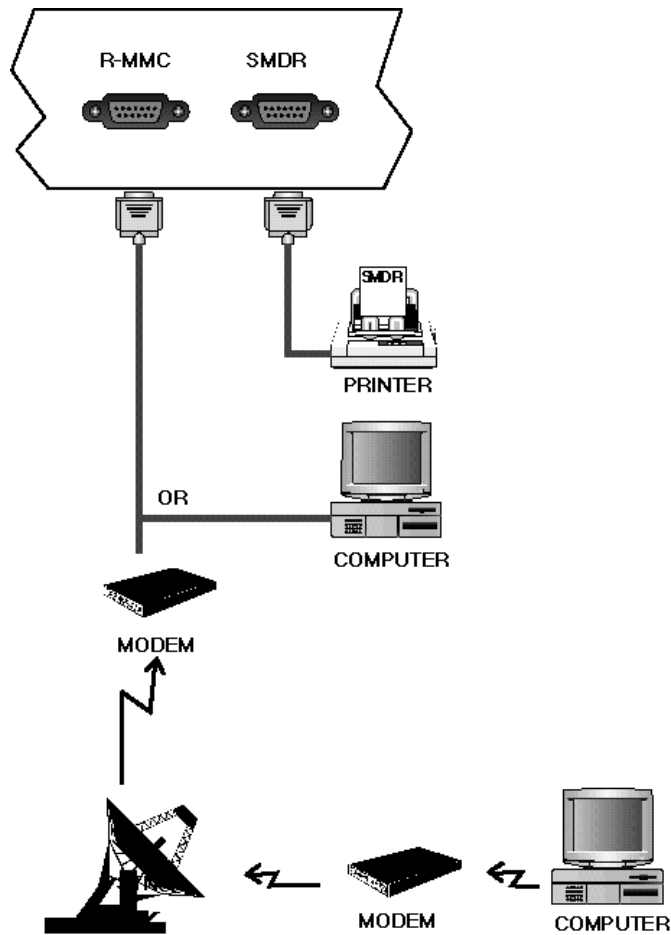

FIGURE 7-4 SMDR & REMOTE PROGRAMMING CONNECTIONS

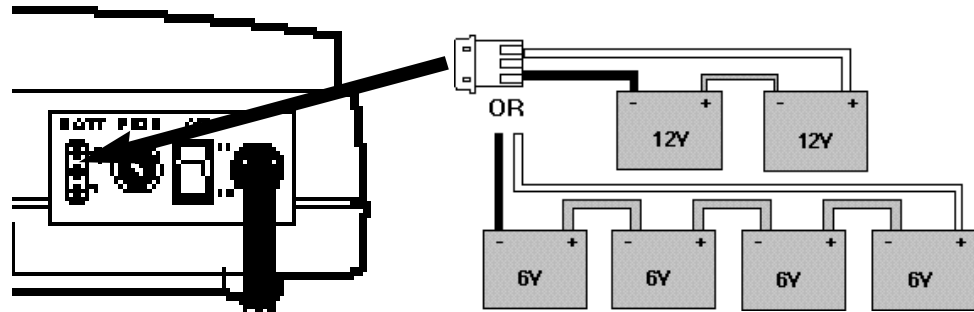

FIGURE 7-5 CONNECTING EXTERNAL BATTERY

8. BEFORE POWER UP

During initial installation, it is best to verify proper system operation before plugging in any amphenol-type cables to the MDF. If you have already plugged the cables in, unplug them. Verify that the AC voltage at the dedicated electric outlet is correct.

Make sure the AC power switch is in the OFF position and memory back-up switch is ON. Plug the KSU power cord into the dedicated polarized AC outlet. Turn the AC power switch to the ON position, and verify the status of the "POWER", "MONITOR", and "IDLE" LEDs on the cover of the KSU. A steady "POWER" LED indicates the presence of power, and a blinking "MONITOR" LED indicates that the main processor is functioning. A steady "IDLE" LED indicates that no one is using the system. If the "POWER" LED fails to illuminate, unplug the system, remove the power supply, and check the AC fuse located on the bottom.

If the fuse is good but the "POWER" LED does not illuminate, you must correct the problem before continuing., Turn off the power switch., Unplug all expansion cards except Base board. Turn the system on. Check the "POWER" LED again. If the problem is corrected, you have a defective card. Test and remove the faulty card before continuing.

If the LED still does not light, unplug the KSU and change power supplies or Base board. This in all probability will solve the problem. If it does not, contact Samsung Technical Support.

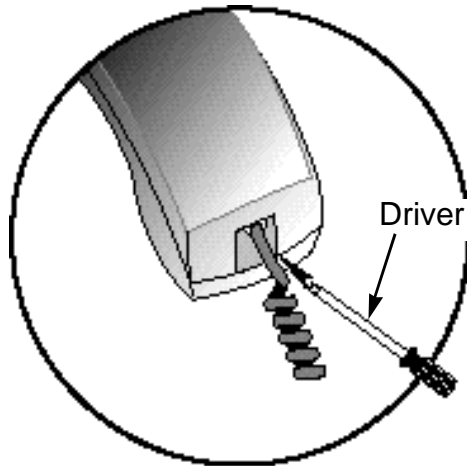
**9-3 HOW TO REMOVE THE HANDSET CORD FROM THE HANDSET**

Insert the sharp-edged one (ex:driver, pincette,...) into the slight gap of handset.

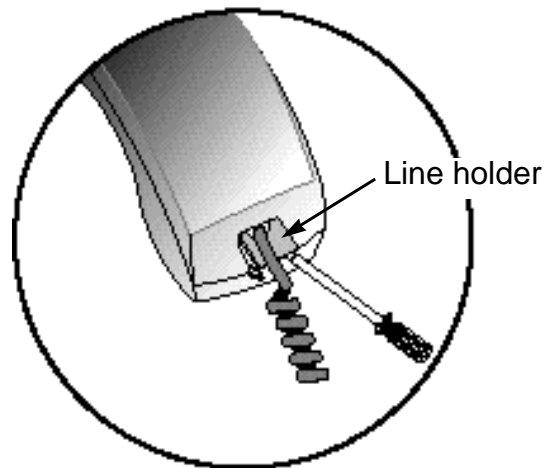

Slightly push the driver, and lift up the line holder from handset.

Now, you have removed the line holder, and can see the modular jack of the handset cord.

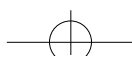

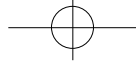

FEATURES SECTION

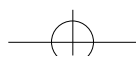

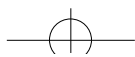
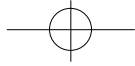

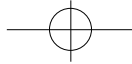

TABLE OF CONTENTS

FEATURES

1. FEATURE DESCRIPTIONS	3-1
1.1 SYSTEM FEATURES	3-1
1.2 STATION FEATURES	3-16
1.3 DISPLAY FEATURES	3-22
2.FEATURE ID TABLE	3-25





.....
NOTICE

this manual describes stadard setting. Some features, MMC Codes and default data may be different from those shown depending on the country.
.....

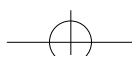

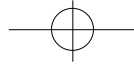

1. FEATURE DESCRIPTION

1.1 SYSTEM FEATURES

ACCOUNT CODE (Voluntary)	LIVE SYSTEM PROGRAMMING
ALL CALL VOICE PAGE	TECHNICIAN LEVEL
ATTENTION TONE	CUSTOMER LEVEL
AUTHORIZATION CODES (Voluntary)	STATION LEVEL
AUTOMATIC HOLD	MEET ME PAGE AND ANSWER
BACKGROUND MUSIC	MESSAGE WAITING INDICATION
BATTERY BACKUP (Memory Protection)	MICROPHONE ON / OFF PER STATION
BATTERY BACKUP (System)	NIGHT SERVICE
CALL FORWARDING	MANUAL NIGHT SERVICE
FORWARD ALL	AUTOMATIC NIGHT SERVICE
FORWARD BUSY	OFF PREMISES EXTENSION (OPX)
FORWARD NO ANSWER	OPERATOR GROUP
EXTERNAL CALL FORWARD	OVERFLOW
CALL HOLD	PAGING
CALL HUNT	PAUSE DIAL
CALL METERING / PRS	PORT STATUS CHECK
CALL PICKUP	POWER FAILURE TRANSFER
CALL WAITING / CAMP-ON	PRIME LINE SELECTION
CENTREX / PBX USE	PRIVATE LINES
CHAIN DIALING	PROGRAMMABLE LINE PRIVACY
CLASS OF SERVICE	PROGRAMMABLE TIMERS
CONFERENCE	RECALLS
DATA SECURITY	REMOTE PROGRAMMING
DIRECT IN LINES	RING OVER PAGE
DIRECT INWARD SYSTEM ACCESS (DISA)	SINGLE-LINE CONNECTIONS
DISA VOICE ANNOUNCEMENT	SPEED-DIAL NUMBERS
DIRECT TRUNK SELECTION	STATION SPEED-DIAL
DIRECTORY NAMES	SYSTEM SPEED-DIAL
DISTINCTIVE RINGING	STATION HUNT GROUPS
DOOR LOCK RELEASE (Programmable)	STATION MESSAGE DETAIL RECORDING (SMDR)
DOOR PHONES (2)	STATION TO STATION CALLING RESTRICTION
DOOR PHONE DAY / NIGHT RING	SYSTEM DIRECTORY
EMERGENCY CALL	SYSTEM HALT
EXECUTIVE BARGE-IN (Override)	TOLL RESTRICTION
EXTERNAL MUSIC INTERFACE	TOLL RESTRICTION OVERRIDE
EXTERNAL PAGE INTERFACE	SYSTEM SPEED-DIAL TOLL RESTRICTION OVERRIDE
FLASH KEY OPERATION	AUTHORIZATION CODE
FLEXIBLE NUMBERING	WALKING CLASS OF SERVICE
FLEXIBLE RINGING	URGENT CODE
HOT / WARM LINE	TONE OR PULSE DIALING
IN GROUP / OUT OF GROUP	TRAFFIC REPORT PRINTOUT
INCOMING CALL DISTRIBUTION	TRANSFER
INCOMING / OUTGOING SERVICE	TRUNK DISCONNECT SIGNAL
INDIVIDUAL LINE CONTROL	TRUNK GROUPS
	UNIVERSAL NIGHT ANSWER (UNA)

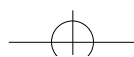

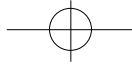
**ACCOUNT CODE (Voluntary)**

Station users may enter an account code of up to seven (7) digits before hanging up a call. This account code will appear in the last column of the SMDR for that call record. Keypad users may enter this code using the ACC button without interrupting a conversation. Single-line set users must temporarily interrupt the call by hook-flashing and dialing the feature access code. If an MPD or PRS board is installed, the Call Metering feature is activated and UNIT and COST will print in the ACCOUNT column of the SMDR.

- ➔ MMC 57 CALL COST
- ➔ MMC 70 DIAL NUMBERING PLAN ACC: 47
- ➔ MMC 71 SYSTEM KEY PROGRAMMING
- ➔ MMC 72 STATION KEY PROGRAMMING

ALL CALL VOICE PAGE

Users can page all keysets and the external paging zone at the same time. Keysets may be restricted from receiving pages via system programming.

- ➔ MMC 22 CUSTOMER ON/OFF

ATTENTION TONE

To attract attention, a brief tone precedes all page announcements or intercom voice calls.

AUTHORIZATION CODES (Voluntary)

Authorization codes are used to validate a station user and give permission to make a call. These voluntary four-digit codes automatically adjust the dialing station's class of dialing service to the level assigned to the code. Certain phone numbers (such as emergency numbers) may be dialed even if the authorization codes are not known. Authorization table numbers are optionally printed on the SMDR.

- ➔ MMC 63 AUTHORIZATION CODE
- ➔ MMC 81 SMDR OPTION

AUTOMATIC HOLD

Station users can enable or disable automatic hold at their keysets. If this feature is enabled, while engaged in an outside call, pressing another trunk key, TRANSFER, CONFERENCE, PAGE or DSS, puts the current call on hold. This is not a user-selectable option.

- ➔ MMC 12 STATION ON/OFF AUTO HOLD: OFF

BACKGROUND MUSIC

Keypad users may choose to hear music through their speakers by pressing the HOLD button while On-Hook. Either of two sources may be jumper-selected on the system base board.

- ➔ MMC 22 CUSTOMER ON/OFF BGM: ON

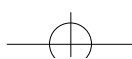

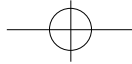
**BATTERY BACKUP (Memory Protection)**

In the event that power is lost to the system, all customer data contained in memory is backed up by a base board Ni/Cd battery sufficient for at least seven (7) days continuous loss of system power. When power is restored, the battery will recharge.

BATTERY BACKUP (System)

If an external 24V battery is connected, the system remains fully operational if AC power is interrupted. Calls in progress are not interrupted when the system switches over. When AC power is restored, the system recharges the batteries. Battery maximum size is limited by charging capacity.

CALL FORWARDING

Allows the user to forward incoming calls under various conditions. Calls can be redirected to the operator group, an external number, or another station or group. If the destination is in DND, the caller will receive a DND tone. Calls cannot be forwarded to a door phone.

- ➔ MMC 11 CALL FORWARD
- ➔ MMC 70 DIAL NUMBERING PLAN
- ➔ MMC 71 SYSTEM KEY PROGRAMMING
- ➔ MMC 72 STATION KEY PROGRAMMING

Forward All

Not affected by the condition of the station. All calls are immediately directed to the designated forwarding destination.

Forward Busy

Forwards calls only while the station is busy. The station user can originate calls as usual.

Forward No Answer

This feature forwards calls not answered within a pre-programmed time. The station user can originate and receive calls normally. The time is programmable on a per-station basis to allow for differences in individual work habits.

External Call Forward

A keyset user can forward calls to an external phone number. Each outside line may be programmed to either follow or ignore station call forwarding.

- ➔ MMC 16 KEY EXTENDER

CALL HOLD

Both outside and internal calls can be put on hold at any station. Users may dial an access code or press the HOLD button to retrieve the held call. If you leave the call on hold longer than the programmed hold recall time, it will re-call your station.

- ➔ MMC 50 SYSTEM TIMERS HOLD RECALL TIME: 045 SEC

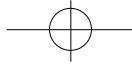

**CHAIN DIALING**

Station users may manually dial additional digits following a Speed-Dial call, or chain together as many Speed-Dial numbers as required.

CLASS OF SERVICE

System programming may assign any of six outgoing call restriction levels. Refer to the TOLL RESTRICTION feature.

➔ MMC 30 STATION TOLL CLASS

CONFERENCE

Any combination of up to 5 parties (stations or outside lines) can be joined together in conference. A station user may also set up the conference with two or more outside lines and then exit the conference leaving the outside lines connected in an unsupervised (trunk to trunk) conference. Conferees may be eliminated or added after a conference has been established.

DATA SECURITY

Single-line stations using modems and facsimile machines can be programmed so that they will not receive any system-generated tones that would disrupt data transmissions.

➔ MMC 39 DATA LINE

DIRECT IN LINES

Outside lines may be programmed to bypass the operator(s) and ring directly at any station, group of stations, or paging system.

➔ MMC 43 ASSIGN TRUNK RING

DIRECT INWARD SYSTEM ACCESS (DISA)

Users can call in on specified DISA lines at any time and receive the system dial tone or pre-programmed voice messages. To make an internal call, dial the station or station group number. To make an outside call, dial the trunk access code. After a short beep tone, dial your own station number and station passcode. If the passcode is correct, the system provides a system dial tone again, and the outside number may be dialed. Some loss of volume may be experienced in this configuration. DISA lines can be used as either incoming only or 2-way lines.

➔ MMC 46 ASSIGN DISA LINE
MMC 01 CHANGE STATION PASSCODE

DISA VOICE ANNOUNCEMENT

DISA lines may use pre-programmed voice messages instead of system tones. Users can access the DISA line normally during the voice announcement.

➔ MMC 42 TRUNK ON/OFF VOICE MSG (VOICE RECORDING 18)

➔ APPENDIX C

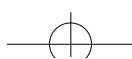

**DIRECT TRUNK SELECTION**

Any station can directly select a specific C.O. line by simply pressing the appropriate button to either originate or answer a call.

DIRECTORY NAMES

Each station and C.O. line may be assigned a unique directory name.

- ➔ MMC 14 STATION NAME
- ➔ MMC 44 TRUNK NAME

DISTINCTIVE RINGING

Users can identify the type of incoming call by the type of ring. Outside calls produce a repeating single ring, while internal calls cause a repeating double ring.

- ➔ MMC 51 TONE/RING CADENCE

DOOR LOCK RELEASE (Programmable)

After answering a call from the door phone, the user can dial a code to activate a contact closure to operate a customer-provided electric door release mechanism. The contact closure timer is programmable from 100-9900 milliseconds. The door lock release contact is a relay dry contact rated for 120VAC/0.5A or 24VDC/1A.

- ➔ MMC 50 SYSTEM TIMERS DOOR RELS: 100 - 2500 MS
DOR R OFF: 1 - 250 S

DOOR PHONES (2)

The system provides for the connection of two door phones. Pressing the button on the door phone sounds a distinctive ring at the assigned stations. If not answered, the system will release the door phone and stop ringing. Stations may call the door phone directly to monitor sounds in the surrounding area. Door phones can be programmed with different day and night ring destinations.

- ➔ MMC 33 ASSIGN DOOR RING

DOOR PHONE DAY / NIGHT RING

Different door phone ringing destinations can be programmed for day and night.

- ➔ MMC 33 ASSIGN DOOR RING

EMERGENCY CALL

The system provides a maximum of five urgent codes. These codes can be accessed by any class of service and are useful to allow access to emergency numbers.

- ➔ MMC 64 OVERRIDE TABLE

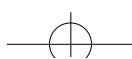

**EXECUTIVE BARGE-IN (Override)**

The feature allows specially-programmed stations to override the automatic privacy of another station. Programming provides three options: No Barge-in, With Tone, and Without Tone. When programmed without tone, the barging-in keyset has its microphone muted. Each station can also be programmed as secure or not secure. Secure stations cannot be barged-in on. A non-secure station talking to a secure station cannot be barged-in on. Each station may also be programmed to enable or disable barge-in.

➔ MMC 24 ASSIGN BARGE-IN

EXTERNAL MUSIC INTERFACE

The system provides internal music on hold (MOH) in the form of a chime. There is also an input for an external audio source. An RCA style phono jack is provided on the Base board for a customer-provided source for music on hold and background music to keysets. Source selection is made via a Base board jumper.

EXTERNAL PAGE INTERFACE

A 600 ohm voice pair is provided for connection to a customer-provided paging system.

FLASH KEY OPERATION

While on an outside line, pressing the FLASH key will flash the central office or PBX. This is used to activate custom calling features on C.O. lines or in conjunction with Centrex/PBX operation. System programming allows adjustment of flash times for C.O. and PBX lines.

➔ MMC 53 TRUNK WIDE TIMERS NEW CALL: 600 msec
FLASH PBX: 600 msec

FLEXIBLE NUMBERING

System programming allows each station a programmable two- or three-digit station number. Re-assignment of these numbers will affect the trunk numbers and other feature IDs.

➔ MMC 70 DIAL NUMBERING PLAN

FLEXIBLE RINGING

Incoming outside calls can be assigned to ring a station or a station group. The system provides separate ringing locations for all trunks in both the DAY and the NIGHT modes.

➔ MMC 43 ASSIGN TRUNK RING

HOT/WARM LINE

Stations can be programmed to call a pre-defined station, station group, outside

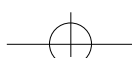

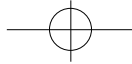
**NX-SERIES** HYBRID KEY SYSTEM

FEATURES SECTION

line, trunk group, or Speed-Dial number whenever the station goes off-hook. A hot line delay time of 1 to 9 seconds can be programmed to allow sufficient time to make a different call.

- ➔ MMC 25 HOT/WARM LINE

IN GROUP / OUT OF GROUP

Individuals assigned to a station hunt group may temporarily remove their telephones from the group by pressing the IOG button. Stations out of a group will not receive calls to that group but will continue to receive calls to their individual extension numbers. When desired, the user may put him/herself back into the group by pressing the button again. Users who do not have this button may dial an access code.

- ➔ MMC 70 DIAL NUMBERING PLAN IOG: 53
- ➔ MMC 71 SYSTEM KEY PROGRAMMING
- ➔ MMC 72 STATION KEY PROGRAMMING

INCOMING CALL DISTRIBUTION

Incoming calls can be assigned to ring a distributed station hunt group. This will allow all members of the group to share the call load.

- ➔ MMC 35 ASSIGN STATION GROUP
- ➔ MMC 43 ASSIGN TRUNK RING

INCOMING / OUTGOING SERVICE

Programming allows any outside line to be used for incoming calls only, outgoing calls only, or both.

- ➔ MMC 31 EXT/TRK USE

INDIVIDUAL LINE CONTROL

Each station in the system can be programmed to allow or deny dialing out. Each outside line may be programmed to allow or deny answering.

- ➔ MMC 31 EXT/TRK USE

LIVE SYSTEM PROGRAMMING

The system can be programmed from any display keyset without interrupting normal system operation. There are three levels of system MMC programming: Technician, Customer, and Station.

- ➔ MMC 20 OPEN PROGRAMMING
- ➔ MMC 21 CHANGE PASSCODE

TECHNICIAN LEVEL

The Technician level has access to all programs via the Technician

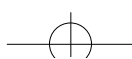

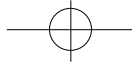

passcode, and can assign Customer level access to MMCs as needed.

CUSTOMER LEVEL

This level requires the Customer level passcode and allows access to MMCs assigned by the Technician level in MMC 90.

- ➔ MMC 90 CUSTOMER USE MMC

STATION LEVEL

All keysets can access MMCs 10 through 17 without using a passcode. Each user can only change data for his/her own keyset.

MEET ME PAGE AND ANSWER

After making an All Page, the user may remain off-hook to allow the paged party to meet the user for a private conversation.

- ➔ MEET ME PAGE : H/F + 56
- ➔ MEET ME ANSWER : 56

MESSAGE WAITING INDICATION

When calling a busy or non-answering station, the caller can leave an indication that a message is waiting. The MESSAGE button will glow red at the called keyset. A single-line phone will receive a distinctive message-waiting dial tone. Up to five message-waiting indications can be left at any station.

- ➔ MMC 70 DIAL NUMBERING PLAN MSA: 43 (Message Answer)
MSC: 42 (Message Clear)
MSL: 41 (Message Left)
- ➔ MMC 71 SYSTEM KEY PROGRAMMING
- ➔ MMC 72 STATION KEY PROGRAMMING

MICROPHONE ON/OFF PER STATION

The microphone can be disabled at any keyset. When a microphone is disabled, the user cannot use the keyset as a speakerphone, although on-hook dialing and group listening are still possible. This feature does not apply to the NX-6B keyset.

- ➔ MMC 22 CUSTOMER ON/OFF MIKE

NIGHT SERVICE

There are two kinds of Night Service: MANUAL and AUTOMATIC.

Manual Night Service

By pressing the NIT button, the system can enter Night Service mode. In Night Service mode, the NIT button lights red. In Day Service mode, the NIT button turns off.

- ➔ MMC 71 SYSTEM KEY PROGRAMMING
- ➔ MMC 72 STATION KEY PROGRAMMING

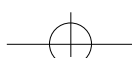

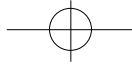
**Automatic Night Service**

Automatic Night Service allows the system to automatically go into and out of Night Service according to system clock time. This feature can be overridden by the Night Service button.

- ➔ MMC 56 ASSIGN AUTO NIGHT TIME

OFF PREMISES EXTENSION (OPX)

A single-line (tip and ring) extension may be connected to telephone company provided off-premises extension (OPX) circuits to remote locations.

OPERATOR GROUP

Stations can be assigned to the operator group for answering incoming calls. Calls to this group can be set for distributed, sequential, conditional, or unconditional ringing. Operators can use the In/Out of Group (IOG) feature to meet varying operator requirements. Group 500 is reserved for the operator group and is called by dialing "0".

- ➔ MMC 35 ASSIGN STATION GROUP

OVERFLOW

When calls ringing a station group go unanswered, they can overflow to another destination after a programmable period of time. Each station group has its own timer. The overflow destination can be a station, station group, or ring over page.

- ➔ MMC 50 SYSTEM TIMERS

PAGING

The system allows for the use of one external and four internal zones. Stations can page any individual zone, all internal zones, the external zone, or all zones. Using system programming, each keyset may be allowed or denied making announcements to any particular zone or receiving pages.

- ➔ MMC 23 PAGE ZONE Internal Page Zone 1, 2, 3, or 4
All Internal Page: 0
- ➔ MMC 22 CUSTOMER ON/OFF All Internal and External Page: ★
PAGE USE: ON/OFF
- ➔ MMC 50 SYSTEM TIMERS PAGE RECEIVE: ON/OFF
PAGE MAX: 1 - 250 SEC

PAUSE DIAL

When dialing an outside call, press [PSE] button to insert a pre-programmed pause time into the current position in the dialed number.

- ➔ MMC 71 SYSTEM KEY PROGRAMMING
- ➔ MMC 72 STATION KEY PROGRAMMING

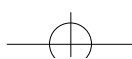

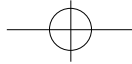
**PORT STATUS CHECK**

Users can view their port status on the LCD. Any one of sixteen (16) status items (IDLE, BUSY, CALLBACK, PROGRAM, etc) may be displayed.

➔ MMC 92 PORT STATUS

POWER FAILURE TRANSFER

In the event of commercial power loss, the first two outside lines can automatically connect to the last two single-line stations. When power is restored to the system, the lines and stations will return to normal operation. Calls in progress at these stations will be disconnected.

PRIME LINE SELECTION

Any station can be programmed to select a specific line, line group, telephone number, station, or station group.

PRIVATE LINES

For private line use, stations can be prevented from dialing and/or answering any line.

➔ MMC 31 EXT/TRK USE

PROGRAMMABLE LINE PRIVACY

Each outside line can be programmed to ignore automatic line privacy. This allows up to four other parties to join your conversation by simply pressing that line button. This is similar to 1A2 key telephone operation.

➔ MMC 42 TRUNK ON/OFF 1A2 EMULATION

PROGRAMMABLE TIMERS

There are 23 programmable system timers to allow the installation to be customized to the end user's application.

➔ MMC 50 SYSTEM TIMERS

RECALLS

Calls put on hold, transferred, or camped-on to any station will recall to the originating station if not answered within the programmed period of time. A recall that goes unanswered for the same period of time will recall to the system operator group. Hold and transfer recalls each have individual programmable timers.

➔ MMC 50 SYSTEM TIMERS

REMOTE PROGRAMMING

NX-SYSTEM remote programming allows the technician to access the system

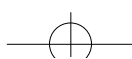

**NX-SERIES** HYBRID KEY SYSTEM

FEATURES SECTION

database from a remote location via a customer-provided modem to make programming changes and view traffic reports as a troubleshooting aid. A customer PC can also be connected directly to the Base board for on-site programming.

➔ MMC 80 IO PARAMETER

RING OVER PAGE

A system-generated ring tone can be programmed on a per-line basis to signal over the external paging system when the system is in Night mode.

➔ MMC 42 TRUNK ON/OFF RING OVER PAGE: OFF

SINGLE-LINE CONNECTIONS

Single-line ports allow for the connection of a variety of single-line telephones, facsimile and answering machines, external bells, modems, cordless phones, and credit card machines. When connecting customer-provided equipment at these stations, compatibility should be verified before purchase to ensure correct operation. Connecting single-line telephones (SLT) to the system may require some programming, depending on the SLT type.

➔ MMC 38 SLT DIALING TYPE (DTMF, PULSE)

SLT Related Timers

HOOK OFF

SLT F MIN

SLT F MAX

➔ MMC 50 SYSTEM TIMERS

Data Security

➔ MMC 39 DATA LINE

SPEED-DIAL NUMBERS**STATION SPEED-DIAL**

Each station has the capability of storing up to twenty Speed-Dial numbers: 00 to 19, each of which may contain a maximum 30 digits.

➔ MMC 17 STATION SPEED-DIAL

SYSTEM SPEED-DIAL

The system can store up to 80 Speed-Dial numbers: 20 to 99, each of which may contain a maximum 30 digits. These system Speed-Dial numbers may be used by any station.

➔ MMC 67 ASSIGN SYSTEM SPEED-DIAL

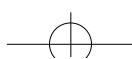

**TOLL RESTRICTION**

There are 250 allow and 250 deny entries of 11 digits each. Each of these entries can apply to dialing classes B, C, D and E. Class A stations have no dialing restrictions and class F stations cannot make outside calls.

- ➔ MMC 30 STATION TOLL CLASS
- ➔ MMC 60 TOLL DENY TABLE/APPLY
- ➔ MMC 61 TOLL ALLOW TABLE/APPLY
- ➔ MMC 65 ASSIGN WILD CHARACTER

TOLL RESTRICTION OVERRIDE

There are several methods of the toll restriction override.

System Speed-Dial Toll Restriction Override

This option allows system Speed-Dial numbers to follow or bypass a station's toll restriction class.

- ➔ MMC 66 SYSTEM SPD-DIAL TOLL RESTRICTION

Authorization Code

Authorization codes are used to validate a station user and give permission to make a call. Each authorization code is associated with a toll class. When the code is entered, the station toll class is changed to that of the authorization code.

- ➔ MMC 63 AUTHORIZATION TABLE

Walking Class of Service

You can change a restricted station's toll class to the same class as your station by entering the walking COS ID, the station number, and the station passcode. The default station passcode '1234' cannot be used.

- ➔ MMC 70 DIAL NUMBERING PLAN COS: 59

Urgent Code

The system provides a maximum of five urgent codes. These codes can be accessed by any class of service, and are useful to allow access to emergency numbers.

- ➔ MMC 64 OVERRIDE TABLE

TONE OR PULSE DIALING

Outside lines can be programmed for either tone or pulse dialing to meet local telephone company requirements.

- ➔ MMC 41 TRUNK DIALING TYPE

TRAFFIC REPORT PRINTOUT

The traffic report contains totals for incoming, outgoing, and intercom calls on a system-wide and a per-station basis. This report can be set to print automatically

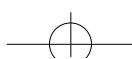

**NX-SERIES** HYBRID KEY SYSTEM

FEATURES SECTION

at the end of each day or week. The report can also be printed on demand. A customer-provided printer must be connected to the SMDR or R-MMC port in order to print this report.

- MMC 80 IO PARAMETERS
- MMC 83 CALL TRAFFIC

TRANSFER

System operation permits station users to transfer calls to other stations in the system. Transfers can be screened, unscreened, or camped-on to a busy station.

TRUNK DISCONNECT SIGNAL

The system can recognize a trunk disconnect signal generated by the Central Office when an outside party hangs up. When the system receives this signal the call is hung up automatically.

TRUNK GROUPS

Outside lines can be grouped for easy access by dialing a code or pressing a button. There are eleven trunk groups available, with access codes 9 and 80 to 89.

- MMC 45 TRUNK GROUP

UNIVERSAL NIGHT ANSWER (UNA)

Stations may dial the Universal Night Answer (UNA) code to answer any outside lines programmed to ring over the paging system.

- MMC 42 TRUNK ON/OFF RING OVER PAGE

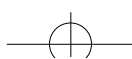

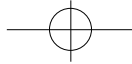

1.2 STATION FEATURES

ADD-ON MODULE (AOM)	MUTE MICROPHONE / HANDSET
APPOINTMENT REMINDER	OFF-HOOK RINGING
AUTOMATIC HOLD	ON-HOOK DIALING
AUTOMATIC PRIVACY	ONE TOUCH DIALING KEYS
BACKGROUND MUSIC	PROGRAMMABLE KEYS
BUSY STATION CALLBACK	PROTECTION FROM BARGE-IN
BUSY STATION INDICATION (BLF)	PULLOUT DIRECTORY TRAY
DIRECT STATION SELECTION (DSS)	PULSE TO TONE SWITCHOVER
DO NOT DISTURB (Programmable)	REDIAL
DOOR LOCK RELEASE	Automatic Redial
EXCLUSIVE HOLD	Last Number Redial
EXECUTIVE/SECRETARY HOT LINES	Saved Number Redial
FORCED AUTO ANSWER	RING MODES
GROUP LISTENING	Ring Mode
HEADSET OPERATION	Auto Answer Mode
HEARING AID COMPATIBLE	Voice Announce Mode
HOT KEYPAD	RINGING LINE PREFERENCE
KEY TONE SELECTION	SPEAKER PHONE
LINE QUEUING WITH CALLBACK	STATION LOCK
LINE SKIPPING	TRI-COLORED LIGHTS
LOUD RINGING INTERFACE	VACANT STATION MESSAGES
MESSAGE WAITING LIGHT / INDICATION	VOLUME SETTINGS
	WALL-MOUNTABLE KEYSETS

ADD-ON MODULE (AOM)

NX-SERIES's unique add-on module (AOM) increases the capability of any station. The 24 programmable buttons can be used as feature keys, DSS/BLF keys, or one-touch Speed-Dial buttons.

- ➔ MMC 37 ASSIGN ADD-ON MODULE
- ➔ MMC 71 SYSTEM KEY PROGRAMMING

APPOINTMENT REMINDER (ALARM CLOCK)

Stations can perform an alarm clock function. Set a specific time and the keyset will give a distinctive ring at that time as a reminder of meetings or appointments. Alarms can be set for "DAY" or "DAILY", and up to three alarm times may be set at each keyset.

- ➔ MMC 26 ALARM REMINDER

AUTOMATIC HOLD

Station users can enable or disable automatic hold at their individual keysets. While engaged on an outside call, pressing another trunk key automatically puts the active call on hold if this feature is enabled. Pressing the TRANSFER, CONFERENCE, PAGE or DSS key always puts calls on hold, and is not a user-selectable option.

- ➔ MMC 12 STATION ON/OFF AUTO HOLD: OFF

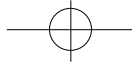

**AUTOMATIC PRIVACY**

All conversations on outside lines and intercom calls are automatically private. The privacy feature can be turned off on a per-line basis.

BACKGROUND MUSIC

While the keyset is on-hook, the HOLD button alternately turns background music (BGM) on or off.

➔ MMC 22 CUSTOMER ON/OFF BGM: ON

BUSY STATION CALLBACK

When reaching a busy station, callers may request a callback by pressing one button or dialing a code (44). The system rings the caller back when that station becomes idle.

BUSY STATION INDICATION (BLF)

DSS/BLF keys may be assigned to any keyset or add-on module. These buttons will be off when the station is idle, glow red when that station is in use, and flash when that station is in DND mode.

DIRECT STATION SELECTION (DSS)

Soft keys can be programmed with extension numbers. Users may press these keys to quickly make or transfer calls to the assigned stations.

DO NOT DISTURB (Programmable)

The Do Not Disturb (DND) feature is used to stop all calls to a station. System programming can allow or deny use of the DND feature for each station. Parties calling a station in DND will receive a distinct DND tone.

➔ MMC 12 CUSTOMER ON/OFF DND: ON

DOOR LOCK RELEASE

Stations programmed to receive calls from a door phone can dial a code to activate a contact closure to control a customer-provided electronic door lock.

➔ MMC 50 SYSTEM TIMERS DOOR RELS: 100 - 2500 MS

EXCLUSIVE HOLD

Pressing the HOLD button twice will hold a call exclusively at that station, allowing no other station to pick up the call.

➔ MMC 50 SYSTEM TIMERS RCAL HOLD: 45 SEC

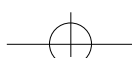

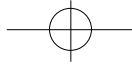
**EXECUTIVE / SECRETARY HOT LINES**

A hands-free communication link is established when the EXECUTIVE/SECRETARY button is pressed. When the EXECUTIVE is in DND mode, all calls are forwarded to the SECRETARY and only the SECRETARY can call the EXECUTIVE. This feature is only available between two keysets. Each SECRETARY station may be associated with two EXECUTIVES, and an EXECUTIVE station has only one SECRETARY.

➔ MMC 36 ASSIGN BOSS/SECRETARY

FORCED AUTO ANSWER

The called station automatically answers via speakerphone. Callers may request this feature by pressing one button or dialing a code (14).

➔ MMC 72 STATION KEY PROGRAMMING

GROUP LISTENING

A keyset assigned this feature may turn on the speaker while using the handset. This allows a group of people to listen to the remote party over the speaker without turning on the microphone and causing interference to the conversation on the line.

➔ MMC 72 STATION KEY PROGRAMMING

HEADSET OPERATION

Each keyset can be programmed to allow the use of a headset. In Headset mode, the hookswitch is disabled and the SPEAKER button is used to answer calls.

➔ MMC 12 STATION ON/OFF HEADSET: OFF

HEARING AID COMPATIBLE

All NX keysets are hearing aid-compatible, as required by part 68 of the FCC requirements.

HOT KEYPAD

If Hot Keypad is enabled, it is not necessary to lift the handset or press the SPEAKER button to begin dialing.

➔ MMC 12 STATION ON/OFF HOT KEYPAD

KEY TONE SELECTION

This feature allows users to hear a slight tone when pressing any keypad button on their keyset.

➔ MMC 12 STATION ON/OFF KEY TONE

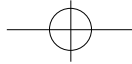

**LINE QUEUING WITH CALLBACK**

When the desired outside line is busy, the user can press the CALLBACK key or dial the access code to place his/her station in the queue awaiting that particular line. The user will be called back when the line becomes available.

LINE SKIPPING

When talking on an outside line and automatic hold is turned off, you may directly press another line key to disconnect without causing the call to go on hold.

MESSAGE WAITING LIGHT / INDICATION

When a message indication is left at a keyset, the MESSAGE button glows red. Single line telephone users will receive a few seconds of interrupted dial tone to notify them that a message is waiting. Message waiting indications can be left for any station or group of stations.

MUTE MICROPHONE / HANDSET

On NX keysets, pressing the MUTE key will cut off the microphone or the handset transmitter depending upon which is in use. 816 keyset users can only mute the microphone. NX-6B keysets have a speaker only and do not have a microphone.

OFF-HOOK RINGING

When a keyset is in use, the system will provide an off-hook ring signal on the keyset speaker, indicating that another call is waiting. The ring signal is a single repeated ring controlled by a system-wide timer. Single line stations will receive a tone burst through the handset.

ON-HOOK DIALING

Any keyset user can originate calls without lifting the handset. When the called party answers, speak into the microphone or lift the handset for more privacy.

ONE-TOUCH DIALING KEYS

Frequently used Speed-Dial numbers can be assigned to one-touch dialing keys for fast, accurate dialing.

➔ MMC 72 STATION KEY PROGRAMMING

PROGRAMMABLE KEYS

NX keysets feature programmable "soft" keys which can be programmed to personalize the operation of each station. Examples of soft key programming options include: individual outside line, individual station line, group of lines, group of stations, and One-Touch dial buttons. Using the soft keys can eliminate the need to remember and dial access codes, long telephone numbers, etc. The Speed-Dial, page, directed pickup, group pickup, door phone and vacant message soft keys have extenders that identify which station, group, or number

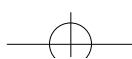



the feature key applies to.

- ➔ MMC 72 STATION KEY PROGRAMMING

PROTECTION FROM BARGE-IN

Each station can be programmed as either secure or not secure. Secure stations cannot be barged-in on. A not secure station talking to a secure station cannot be barged-in on.

- ➔ MMC 24 ASSIGN BARGE-IN

PULL-OUT DIRECTORY TRAY

A pull-out telephone number directory tray is conveniently located beneath all keysets.

PULSE TO TONE SWITCHOVER

When dialing a number on a pulse dial network, a station user can dial ' # ', and the system will begin to send DTMF tones.

REDIAL

There are three types of external redial available to all station users:

Automatic Redial

When you dial an outside number and receive a busy signal, use the automatic redial feature to reserve an outside line and automatically redial the number for a programmable number of attempts.

- ➔ MMC 50 SYSTEM TIMERS
- ➔ MMC 52 SYSTEM WIDE COUNTER
- ➔ MMC 72 STATION KEY PROGRAMMING

Last Number Redial

The most recent number dialed on a C.O. line is automatically saved and may be redialed by pressing the REDIAL button or dialing the LNR ID.

- ➔ MMC 72 STATION KEY PROGRAMMING

Saved Number Redial

A number just dialed on a C.O. line may be saved by pressing the pre-programmed SNR button or dialing the SNR feature code (17). The number may be redialed by pressing the SNR button or dialing the SNR ID.

- ➔ MMC 70 DIAL NUMBERING PLAN SNR: 17
- ➔ MMC 72 STATION KEY PROGRAMMING

RING MODES

Each user can select one of three ways to receive intercom calls. The phone can ring normally, automatically answer via speakerphone, or voice announce

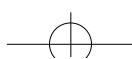

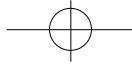

through the speaker.

Ring Mode

Calls are answered by pressing the SPEAKER button or by lifting the handset.

Auto Answer Mode

The keyset will automatically answer calls via the speakerphone.

Voice Announce Mode

Keyset users can hear the caller's voice, but caller cannot hear the user. After the answer, press the SPEAKER button or lift the handset, and the caller will hear the user's voice.

➔ MMC 10 SET ANSWER MODE

RINGING LINE PREFERENCE

Lifting the handset or pressing the SPEAKER button will answer a call to the keyset. Using this method, users are assured of answering the oldest call first. When ringing preference is turned off, the user must press the flashing button to answer. Users may answer ringing lines in any order by pressing the associated flashing button.

➔ MMC 12 STATION ON/OFF RING PREFERENCE

SPEAKER PHONE

Keysets have a built-in speakerphone. If the microphone is enabled on the keyset, calls can be made and received without using the handset. The NX-6B keyset does not have a microphone, therefore speakerphone operation is not possible.

➔ MMC 22 CUSTOMER ON/OFF MIKE

STATION LOCK

Station locking prohibits another person from using your station. The system provides two kinds of locking. When LOCKED1 is selected, dialing from your station is prohibited, but answering calls is permitted. When LOCKED2 is selected, both dialing and answering calls are prohibited. In UNLOCK condition, dialing and answering are normal.

➔ MMC 00 STATION LOCK

TRI-COLORED LIGHTS

Keysets make use of tri-colored Light Emitting Diodes (LEDs). Outside calls in use at a keyset glow green at the using station, and red at all others. Recalls to these keysets will glow amber (red and green together).

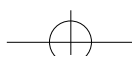



VACANT STATION MESSAGES

Any keyset may select one of twenty messages to be displayed at a calling party's keyset. Ten messages are fixed, and the remaining ten can be customized by the system administrator (16 character maximum).

01 IN A MEETING	06 OUT OF TOWN
02 OUT ON A CALL	07 IN TOMORROW
03 OUT TO LUNCH	08 RETURN AFTERNOON
04 LEAVE A MESSAGE	09 ON VACATION
05 PAGE ME	10 GONE HOME

NOTE : The calling party must have a display keyset to view these messages.

➔ MMC 27 VACANT MESSAGE

VOLUME SETTINGS

Each keyset may adjust the volume of the ringer, speaker, and handset receiver independently. NX keysets use VOLUME (+) and (-) to adjust these levels.

WALL-MOUNTABLE KEYSETS

Every keyset and add-on module comes equipped with a reversible base wedge.

1.3 DISPLAY FEATURES

ACCOUNT CODE DISPLAY	ENHANCED STATION PROGRAMMING
CALL DURATION TIMER	IDENTIFICATION OF RECALLS
CALL FOR GROUP IDENTIFICATION	IDENTIFICATION OF TRANSFERS
CALL PROCESSING INFORMATION	MESSAGE WAITING CALLER NUMBER
CALLING PARTY NAME	MULTI-LANGUAGE DISPLAY (3 choices)
CALLING PARTY NUMBER	OUTSIDE LINE IDENTIFICATION
CONFERENCE INFORMATION	OVERRIDE IDENTIFICATION
DATE AND TIME DISPLAY (4 formats)	STOPWATCH TIMER
DIALED NUMBER	VACANT STATION MESSAGE DISPLAY

ACCOUNT CODE DISPLAY

Account codes are conveniently displayed for easy confirmation. If entered incorrectly, users may press the ACC key again and re-enter the account code.

CALL DURATION TIMER

The system can automatically time outgoing calls and show the duration in hours, minutes and seconds. Station users may manually time calls by pressing the TIMER button.

➔ MMC 12 STATION ON/OFF AUTO TIMER



**CALL FOR GROUP IDENTIFICATION**

When a call is made to a station group, the display will show the called group number. These calls can be answered with a different greeting than calls to the user's extension number.

CALL PROCESSING INFORMATION

During everyday call handling, the keyset display will provide information that is helpful and in some cases invaluable. Under some conditions, the user is prompted to take action, and in other cases the user receives directory information.

CALLING PARTY NAME

For intercom calls, display keysets show the calling party's name when answering. The names can be up to 12 characters long, and must be stored in the system directory list.

➔ MMC 14 STATION NAMES

CALLING PARTY NUMBER

When receiving an intercom call, all display stations show the calling party's extension number.

CONFERENCE INFORMATION

When setting up a conference, each extension and outside line number is displayed at the controlling station as it is added. When a station is added to a conference, its own display will show ' CONFERENCE 203 ', alerting the user that other parties are on the line.

DATE AND TIME DISPLAY (4 formats)

In an idle state, the current date and time are conveniently displayed in the keyset LCD. Keysets can display the time in 12 or 24 hour clock in either EASTERN or WESTERN format.

NOTE : Only Western format display is available in SKP-816 type telephones.

➔ MMC 15 DATE DISPLAY

DIALED NUMBER

When making outside calls, the dialed digits are displayed as the user dials them. If the display indicates an incorrect number has been dialed, the user can quickly hang up before billing begins.

ENHANCED STATION PROGRAMMING

Personal programming options are easier to select and confirm with the help of the display.

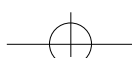

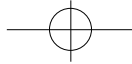
**IDENTIFICATION OF RECALLS**

Hold and Transfer recalls are identified differently. Hold recalls show [HOLD RECALL 203] and Transfer recalls show [RECALL FROM 204].

IDENTIFICATION OF TRANSFERS

The display identifies who has transferred a call to the user [TRSF. FROM 206] and also shows when a call is camped-on to the user's station.

MESSAGE WAITING CALLER NUMBER

When the message indication is on, pressing the MESSAGE button will display the station number of the person who has messages for the user. Display keysets can scroll up and down through the message notifications.

MULTI-LANGUAGE DISPLAY (3)

Three LCD languages are available:

ENTRY NO.	LANGUAGE
1	ENGLISH
2	SPANISH
3	PORTUGUESE

NOTE: When in MMC mode, English is displayed.

➔ MMC 93 SELECTION LANGUAGE

OUTSIDE LINE IDENTIFICATION

Each line can be identified with a name or ID. Incoming calls ringing at your station will display this ID until the call is answered. This is helpful when lines need to be answered with different greetings.

➔ MMC 44 TRUNK NAMES

OVERRIDE IDENTIFICATION

If another station barges-in on a user's conversation, the display will alert him/her with a [206 BARGED IN] display.

STOPWATCH TIMER

Display keyset users will find this feature very convenient to time meetings, calls, and other functions. Simply press to start the timer, and press again to stop.

➔ MMC 12 STATION ON/OFF

VACANT STATION MESSAGE DISPLAY

Vacant station messages set by other stations display at the user's station when they are called.

➔ MMC 27 VACANT MESSAGE

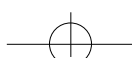

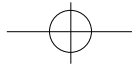

2. FEATURE ID TABLE

FEATURE	FEATURE ID
Operator Group	0
Hold Pickup Pickup Page Hold Direct Pickup	10 + Station / Trunk number
Hold	H/F + 11
Call Secretary	12
Call Boss	12 + 1 / 2
Open Doorphone	H/F + 1
Call Doorphone	13 + 1 / 2
Direct Open Doorphone	13 + 3 / 4
Forced Auto Answer	H/F + 14
Program Personal Speed-Dial	15 + Personal Speed-Dial number (00 ~ 19) + telephone number + H/F
Speed-Dial	16 + Speed-Dial number (00 ~ 99)
Saved Number Redial	17
Voice Recording	18
Last Number Redial	19
Barge-In	40
Leave a Message	H/F + 41, 41 + Station / Group number
Cancel a Message	42 + Station / Group number
Return a Message	43
Callback	H/F + 44
Camp-On	H/F + 45
Conference	H/F + 46
Account Code	H/F + 47
Set Vacant Message	48 + Message number (01 ~ 20)
Cancel Vacant Message	48 + 00
C.O. Flash (New Call)	H/F + 49
Group In/Out	53 + 1 / 0
Change Station Passcode	54 + old passcode + new passcode
Page All	55 + *
Page All internal zones	55 + 0
Page internal zones 1 to 4	55 + 1, 2, 3, or 4
Page external zone	55 + 5
Meet Me Page	H/F + 56
Meet Me Answer	56
Set Alarm	58 + HH + MM
Cancel Alarm	58 + 3
Walking Class of Service	59 + station number + station passcode
Cancel Call Forward	60
Set Call Forward All	61 + 1 + station no. / station group no.
Cancel Call Forward All	61 + 0
Set Call Forward Busy	62 + 1 + station no. / station group no.
Cancel Call Forward Busy	62 + 0
Set Call Forward No Answer	63 + 1 + station no. / station group no.
Cancel Call Forward No Answer	63 + 0
DND	64 + 1 / 0
Toll Override	65 + Authorization Code
My Number	#
Group Pickup	66 + pickup group(Ø~9)
UNA Pickup	67
Set Answer Mode	68 + 1 / 2 / 3
Headset	69 + 1 / 0
Pickup Group	*
Pulse to Tone Changeover	Dial telephone number + # + codes

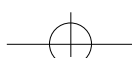

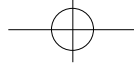

PROGRAMMING SECTION

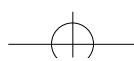



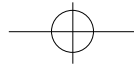

TABLE OF CONTENTS

PROGRAMMING

- 1. INTRODUCTION TO PROGRAMMING 4-1**
- 1.1 PROGRAMMING OVERVIEW 4-1
- 1.2 PROGRAMMING LEVELS 4-1
- 1.3 PROGRAM KEYS 4-2
 - 1.3.1 NX keyset with LCD 4-2
 - 1.3.2 Other LCD keysets 4-3

- 2. PROGRAMMING PROCEDURES..... 4-4**
- 2.1 PROGRAM LIST IN NUMERICAL ORDER..... 4-4
- 2.2 PROGRAM LIST IN ALPHABETICAL ORDER 4-5
- 2.3 PROGRAM PROCEDURES 4-6





.....
NOTICE

this manual describes stadard setting. Some MMC Codes and default data may be different from those shown depending on the country.

.....

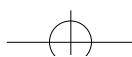



1. INTRODUCTION TO PROGRAMMING

1.1 PROGRAMMING OVERVIEW

The system arrives from the factory with default data entered. Connect it to trunks, stations, and power, turn the system on and it is fully operational. The only thing left to do is customize the data to fit the customer's needs. This is called programming the system.

MMC stands for **Man Machine Code**, and each program is assigned a different two digit code. MMCs are used to view, create, or change customer data. Programming is simply deciding what needs to be done and knowing which MMC is used to do it.

System programming may be done from any NX-24E or NX-12E keyset (Refer to 1.3.1) or any keyset with LCD (Refer to 1.3.2). The first thing to do is open system programming. As a security measure, a passcode must be known to do this.

1.2 PROGRAMMING LEVELS

There are three levels of programming: SYSTEM, CUSTOMER and STATION. System and Customer levels are under passcode protection while station programming does not require a passcode.

To prevent conflicting data from being entered, only one person at a time can enter programming with the technician or customer passcode. While programming is in progress, normal system operation is not affected.

SYSTEM LEVEL

This level is entered via MMC 20 and requires the Technician Level passcode. It allows access to all system, station, and maintenance programs.

CUSTOMER LEVEL

This level is entered via MMC 20 and requires the Customer passcode. It allows access to station and system programs assigned by the Technician Level in MMC 90. When using the customer passcode to access station programs, data for all stations can be viewed or changed.

STATION LEVEL

All keysets can access station programs 10 through 17 without using a passcode. Each user can only change data for his/her own keyset.

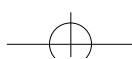

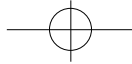

1.3 PROGRAM KEYS

1.3.1 NX-keyset with LCD

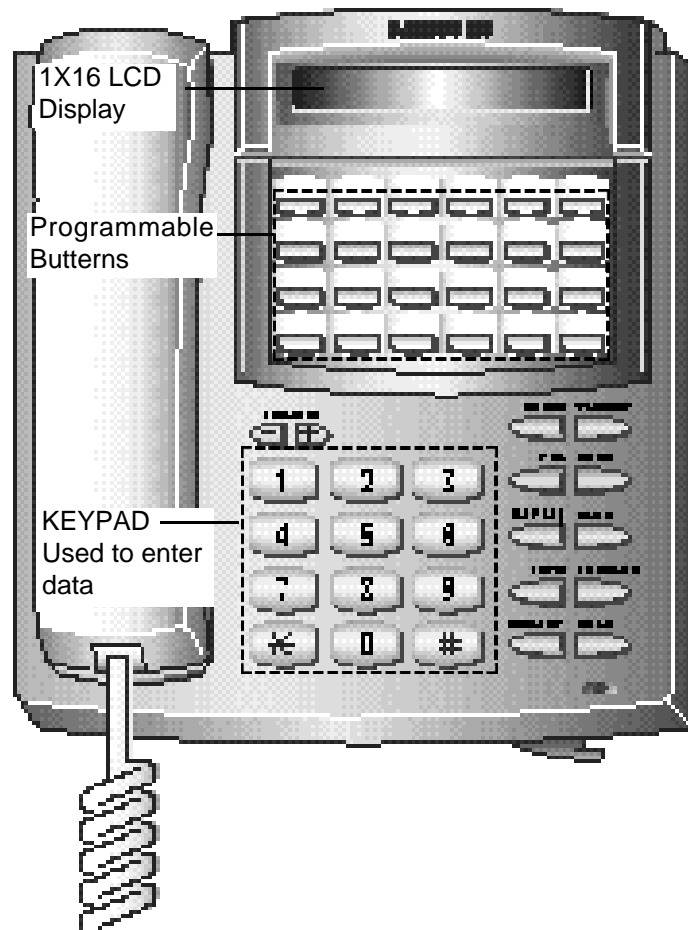

- VOLUME (+) or (-)** : Used to scroll through stations or trunks.
- MUTE or MESSAGE** : Usually used to select data.
- TRANSFER** : Used to enter the programming mode.
Also used to save changes and exit the program.
- SPEAKER** : Used to save changes and advance to the next program.
- HOLD** : Usually used to clear previous data.



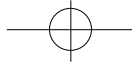

1.3.2 Other LCD keysets

When the using other types of LCD keysets, such as the AS-30 or 816, programming key assignments will differ from the NX model, as shown in the box below.

AS-Keypad	NX-keyset	816 keypad
TRSF/ALM	TRANSFER	AUTO RDL
N/A	SPEED	ALM/SD
RD	REDIAL	RD
FLASH	FLASH	BOSS/SECR
N/A	CALLBACK	CONF
PAGE	PAGE	PAGE
FUNC/DND	MUTE	MUTE/DND
MSG	MESSAGE	MSG
SPK	SPEAKER	SPK
HOLD	HOLD	HOLD
VOLUME	VOLUME (-)/(+)	TIMER/AUTO ANS



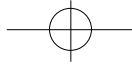

2. PROGRAMMING PROCEDURES

2.1 PROGRAM LIST IN NUMERICAL ORDER

00:	STATION LOCK	45:	TRUNK GROUP
01:	CHANGE STATION PASSCODE	46:	ASSIGN DISA LINE
10:	SET ANSWER MODE	50:	SYSTEM TIMERS
11:	CALL FORWARD	51:	TONE/RING CADENCE
12:	STATION ON/OFF	52:	SYSTEM WIDE COUNTER
13:	SET RING FREQUENCY	53:	TRUNK WIDE TIMERS
14:	STATION NAMES	54:	MAKE/BREAK RATIO
15:	DATE DISPLAY	55:	CURRENT DATE AND TIME
16:	KEY EXTENDER	56:	ASSIGN AUTO NIGHT TIME
17:	STATION SPEED-DIAL	57:	CALL COST
20:	OPEN PROGRAMMING	60:	TOLL DENY TABLE/APPLY
21:	CHANGE PASSCODE	61:	TOLL ALLOW TABLE/APPLY
22:	CUSTOMER ON/OFF	62:	PBX ACCESS CODE
23:	PAGE ZONE	63:	AUTHORIZATION TABLE
24:	ASSIGN BARGE-IN	64:	OVERRIDE TABLE
25:	HOT/WARM LINE	65:	ASSIGN WILD CHARACTER
26:	ALARM REMINDER	66:	SYSTEM SPD-DIAL TOLL RESTRICTION
27:	VACANT MESSAGE	67:	ASSIGN SYSTEM SPEED-DIAL
28:	CALL DISC RESTRICTION		
30:	STATION TOLL CLASS	70:	DIAL NUMBERING PLAN
31:	EXT/TRK USE	71:	SYSTEM KEY PROGRAMMING
32:	INTERCOM USE	72:	STATION KEY PROGRAMMING
33:	ASSIGN DOOR RING	73:	KEY TEST
34:	ASSIGN PICKUP GROUP		
35:	ASSIGN STATION GROUP	80:	SYSTEM I/O PARAMETERS
36:	ASSIGN BOSS/SECRETARY	81:	SMDR OPTIONS
37:	ASSIGN ADD-ON MODULE	83:	CALL TRAFFIC
38:	SLT DIALING TYPE		
39:	DATA LINE	90:	CUSTOMER USE MMC
		91:	SYSTEM VERSION
40:	C.O./PBX LINE	92:	PORT STATUS
41:	TRUNK DIALING TYPE	93:	LANGUAGE SELECTION
42:	TRUNK ON/OFF	94:	HALT PROCESS
43:	ASSIGN TRUNK RING	95:	SYSTEM RESTART
44:	TRUNK NAMES		



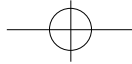

2.2 PROGRAM LIST IN ALPHABETICAL ORDER

ALARM REMINDER	26	LANGUAGE SELECTION	93
ASSIGN ADD-ON MODULE	37	MAKE/BREAK RATIO	54
ASSIGN AUTO NIGHT TIME	56	OPEN PROGRAMMING	20
ASSIGN BARGE-IN	24	OVERRIDE TABLE	64
ASSIGN BOSS/SECRETARY	36	PAGE ZONE	23
ASSIGN DISA LINE	46	PBX ACCESS CODE	62
ASSIGN DOOR RING	33	PORT STATUS	92
ASSIGN PICKUP GROUP	34	SET ANSWER MODE	10
ASSIGN STATION GROUP	35	SET RING FREQUENCY	13
ASSIGN SYSTEM SPEED-DIAL	67	SLT DIALING TYPE	38
ASSIGN TRUNK RING	43	SMDR OPTIONS	81
ASSIGN WILD CHARACTER	65	STATIONKEY PROGRAMMING	72
AUTHORIZATION TABLE	63	STATION LOCK	00
C.O./PBX LINE	40	STATION NAMES	14
CALL COST	57	STATION ON/OFF	12
CALL DISC	28	STATION SPEED-DIAL	17
CALL FORWARD	11	STATION TOLL CLASS	30
CALL TRAFFIC	83	SYSTEM I/O PARAMETERS	80
CHANGE PASSCODE	21	SYSTEMKEY PROGRAMMING	71
CHANGE STATION PASSCODE	01	SYSTEM RESTART	95
CURRENT DATE AND TIME	55	SYSTEM SPD-DIAL TOLL RESTRICTION	66
CUSTOMER ON/OFF	22	SYSTEM TIMERS	50
CUSTOMER USE MMC	90	SYSTEM VERSION	91
DATA LINE	39	SYSTEM WIDE COUNTER	52
DATE DISPLAY	15	TOLL ALLOW TABLE/APPLY	61
DIAL NUMBERING PLAN	70	TOLL DENY TABLE/APPLY	60
EXT/TRK USE	31	TONE/RING CADENCE	51
HALT PROCESS	94	TRUNK DIALING TYPE	41
HOT/WARM LINE	25	TRUNK GROUP	45
INTERCOM USE	32	TRUNK NAMES	44
KEY EXTENDER	16	TRUNK ON/OFF	42
KEY TEST	73	TRUNK WIDE TIMERS	53
		VACANT MESSAGE	27





2.3 PROGRAM PROCEDURES

The following instructions for each MMC assume that you have already opened programming.

To open **SYSTEM (CUSTOMER) PROGRAMMING**:

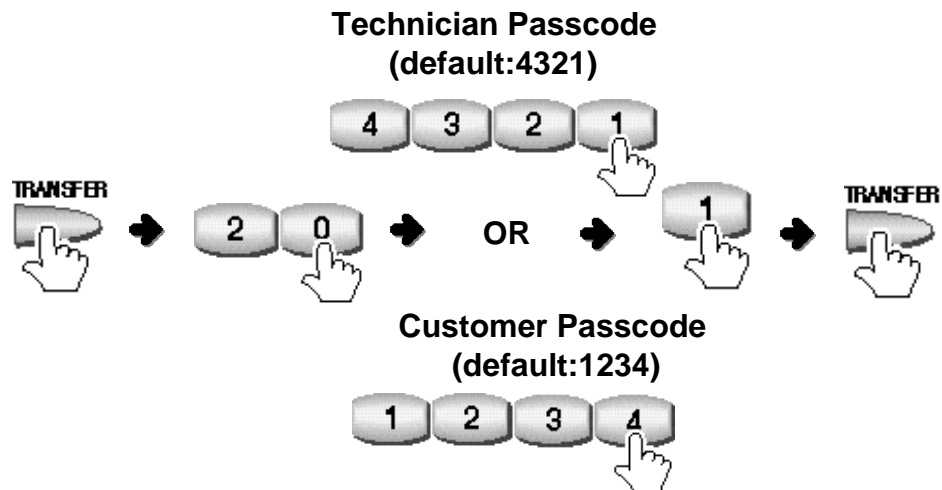

When finished programming MMCs 00 through 95 and have other programming to do, press **[SPEAKER]** to exit the MMC and stay in the programming mode. Then perform one of the following operations:

- 1) Dial another MMC code directly and continue programming.
- 2) Press **[VOLUME](+)** and **(-)** keys to scroll through all MMC codes. When the desired MMC code is reached, press **[SPEAKER]** and continue programming.

Pressing **[TRANSFER]** will always save changes and exit the programming mode.

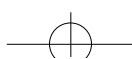

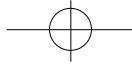

MMC 00

STATION LOCK

Use this MMC to lock or unlock stations in order to control others using your station.

UNLOCK	Normal status
LOCKED1	Prohibit another user from making outside call.
LOCKED2	Prohibit another user from dialing or receiving any calls.

PROCEDURE

LCD DISPLAY

1. Press **[TRANSFER]** and dial **00**

201: UNLOCKED

2. Using **[VOLUME (-)]** or **[+]**, select a station (e.g. 202)
*To select all stations, press **[VOLUME (-)]** first*

202: UNLOCKED

3. Press **[MUTE]** or **[MESSAGE]** to make selections
 OR
 Using KEYPAD, dial
0 for **UNLOCKED**
1 for **LOCKED1**
 or **2** for **LOCKED2**

202: LOCKED1

4. Press **[TRANSFER]** to save and exit

DEFAULT DATA

UNLOCKED

RELATED MMC

MMC 01 CHANGE USER PASSCODE

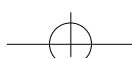

**MMC 01****CHANGE STATION PASSCODE**

This MMC is used to reset any keyset's passcode to its default value of '1234', and cannot display station passcodes.

Keyset users can set or change their individual passcodes, which are used to lock or unlock the keyset and to access the WALKING CLASS of service and DISA calls.

NOTE : Users must enter unique passcodes for using the STATION LOCK, DISA, and WALKING CLASS of service. The default passcode does not apply.

PROCEDURE**LCD DISPLAY**

1. Press **[TRANSFER]** and dial **01**



2. Using **[VOLUME (-) or (+)]**, select a station (e.g. 202)
To select all stations, press **[VOLUME (-)]** first



3. Press **[HOLD]** to reset the selected station's passcode to default data '1234'
If you forget passcode, use this MMC



4. Press **[TRANSFER]** to save and exit

DEFAULT DATA

1234

RELATED MMC

MMC 00 STATION LOCK

MMC 46 ASSIGN DISA LINE





MMC 10

SET ANSWER MODE

This MMC is used to change the answer mode of any station to one of the following options:

- 1 RING** The keyset will ring. Calls are answered by pressing [SPEAKER], or by lifting the handset.
- 2 AUTO ANSWER** After a short attention tone, the key set will automatically answer calls via speakerphone. When a C.O. line is transferred to a keyset in Auto Answer Mode, the keyset will ring until pressing [SPEAKER], or lifting the handset.
- 3 VOICE ANNOUNCE** The keyset will not ring. After a short attention tone, caller can make an announcement but [SPEAKER] button or handset must be used to respond to the caller.

PROCEDURE

LCD DISPLAY

1. Press [TRANSFER] and dial 10	
2. Using [VOLUME (-) or (+)], select a station (e. g. 202) <i>To select all stations, press [VOLUME (-)] first</i>	
3. Press [MUTE] or [MESSAGE] to make selection OR Using KEYPAD, dial 1 for RING 2 for AUTO ANSWER or 3 for VOICE ANNOUNCE (e.g. 2)	
4. Press [TRANSFER] to save and exit	

DEFAULT DATA

RING

RELATED MMC

NONE

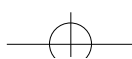

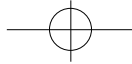

MMC 11

CALL FORWARD





This MMC is used to program the call forwarding destination for each station and to set the time for FORWARD NO ANSWER.

Each station can forward calls under the following condition.

FORWARD ALL	All calls are forwarded to destination station
FORWARD BUSY	If the station is busy, calls are forwarded to destination station.
FORWARD NO ANSWER	If the station doesn't answer within the 'no answer' time, calls are forwarded to destination.
NO ANSWER TIME	Used to set 'no answer' time. This time is also used for External Call Forward.

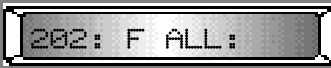
PROCEDURE

LCD DISPLAY

1. Press [TRANSFER] and dial 11	
2. Using [VOLUME (-) or (+)] , select station (e. g. 202)	
3. Press [REDIAL] or [FLASH] to select the forwarding method described above (e.g. FORWARD NO ANSWER)	
4. Enter the destination station To clear the data, press [HOLD]	
<i>If your selection is NO ANSWER TIME, enter a 3 digit time in seconds</i>	
5. Press [TRANSFER] to save and exit	

DEFAULT DATA

FORWARD TYPE : NONE
NO ANSWER TIME : 015 SEC

RELATED MMC

NONE



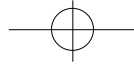

MMC 12

STATION ON/OFF

This MMC allows the keyset user to set the following features:

AUTO HOLD	Places an existing C.O. call on hold if another trunk key (C.O. button) is pressed during that call.
AUTO TIMER	Automatically starts stopwatch timer during a C.O. call.
HEADSET USE	When ON, this feature disables the hook switch, allowing a headset user to answer calls by pressing [SPEAKER]
HOT KEYPAD	When ON, this feature allows the user to dial directory numbers without having to first lift the handset or press the [SPEAKER] button.
KEY TONE	When ON, this feature allows the user to hear a slight tone when pressing keypad numbers on their set.
RING PREFERENCE	When OFF, requires the user to press the fast flashing button to answer a ringing call after lifting the handset.

PROCEDURE

LCD DISPLAY

1. Press [TRANSFER] and dial 12	201:A HOLD:OFF
2. Using [VOLUME (-) or (+)], select a station (e. g. 202) <i>To select all stations, press [VOLUME (-)] first</i>	202:A HOLD:OFF
3. Press [REDIAL] or [FLASH] to select the keyset features described above (e.g. HEADSET USE)	202:HEDSET:OFF
4. Press [MUTE] or [MESSAGE] to make a selection OR Using KEYPAD, dial 0 for OFF or 1 for ON (e.g. 1)	202:HEDSET:ON
5. Press [TRANSFER] to save and exit	

DEFAULT DATA

AUTO HOLD	: OFF
AUTO TIMER	: ON
HEADSET	: OFF
HOT KEYPAD	: ON
KEY TONE	: ON
RING PREFERENCE	: ON

RELATED MMC

NONE

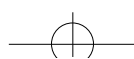

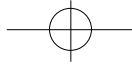
**MMC 13****SET RING FREQUENCY**

This MMC is used to select the ring frequency at each keyset. There are four types of ring frequency available at each keyset. A sample of the selection can be heard when a dial key pad is pressed.

PROCEDURE**LCD DISPLAY**

1. Press **[TRANSFER]** and dial **13**
Display shows current ring frequency



2. Using **[REDIAL]** or **[FLASH]**, select the station you want (e.g. 202)
*To select all stations, press **[REDIAL]** first*



3. Press **[MUTE]** or **[MESSAGE]** to make selection.
A sample of selected frequency will be heard
OR
Using keypad, dial



- 1** for **FREQUENCY 1**
- 2** for **FREQUENCY 2**
- 3** for **FREQUENCY 3**
- 4** for **FREQUENCY 4** (e.g. 2)

4. Press **[TRANSFER]** to save and exit

DEFAULT DATA

FREQUENCY 1

RELATED MMC

NONE

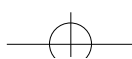

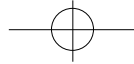

MMC 14

STATION NAMES

This MMC is used to enter a name of up to twelve (12) characters to identify an individual station.

Names are entered via the keypad. Each press of a key will select a character.

Pressing a different key will advance the cursor to the next position.

For example if the station name is "SAM SMITH", press the number "7" four times to get the letter "S". The characters programmed by each dial pad are listed below:

Dial Count	1	2	3	4	5	6	7	8	9	0	*	#
1	Q	A	D	G	J	M	P	T	W	:	?	
2	Z	B	E	H	K	N	R	U	X	.	&	[
3		C	F	I	L	O	S	V	Y	!	\$]
4	1	2	3	4	5	6	7	8	9	0	*	#

NOTE : When the character you want appears on the same dial pad key as the previous character, press [FLASH] to move the cursor to right.

PROCEDURE

LCD DISPLAY

1. Press [TRANSFER] and dial 14



2. Using [VOLUME (-) or (+)], select a station (e.g. 202)
To select all stations, press [VOLUME (-)] first



3. Referring to the above list, the enter station name.
Use [FLASH] to advance cursor to the right
(up to 12 digits)



4. Press [TRANSFER] to save and exit

DEFAULT DATA

Model name

RELATED MMC

NONE





MMC 15

DATA DISPLAY

This MMC is used to change date display mode of each stations. Following date display mode are available.

NOTE: AS-30S and SKP-816 model keysets display Western format only.

1	24 WESTERN	WED 21 JUN 17:37
2	12 WESTERN	WED 21 JUN 05:37
3	24 EASTERN	06/21 WED 17:37
4	12 EASTERN	06/21 WED 05:37

PROCEDURE

LCD DISPLAY

1. Press **[TRANSFER]** and dial **15**

2. Using **[VOLUME (-)]** or **[+]**, select a station (e.g. 202)
*To select all stations, press **[VOLUME (-)]** first*

3. Press **[MUTE]** or **[MESSAGE]** to make selection
 OR

Using the KEYPAD, dial

1 for 24 WESTERN

2 for 12 WESTERN

3 for 24 EASTERN

or **4 for 12 EASTERN** (e.g. 3)

4. Press **[TRANSFER]** to save and exit

DEFAULT DATA

12 WESTERN

RELATED MMC

MMC 55 CURRENT DATE AND TIME



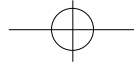

MMC 16

KEY EXTENDER

This MMC is used to view the programmable keys assigned to a keyset station. It also allows the system administrator to assign key extenders to some keys to make a feature key more specific. The feature keys accept extenders are:

FEATURE KEY	EXTENDER
FWE	External Call Forward(00~99)
SPEED	Dial (00~99)
VAC	Vacant messages (01~20)
PAG	Page (0~5,★)
DOR	Door & Door Lock control (1~4)
EXC	Boss and Secretary (1~2)
DPC	Direct Pickup (station / trunk-line number)
GPC	Group Pickup (0~9)

PROCEDURE

LCD DISPLAY

1. Press **[TRANSFER]** and dial **16**

201 01:701:

2. Using **[VOLUME (-) or (+)]**, select a station (e.g. 202)

202 01:701

3. Press **[REDIAL]** or **[FLASH]** to select a feature key button (e.g. 22)

OR

Press the button you want to extend if it is already programmed.

202 22:PAG1

4. Dial the extender according to the above table.
A previous extender will be overwritten
*To clear the extended key, press **[HOLD]***

202: 22:PAG2

5. Press **[TRANSFER]** to save and exit

DEFAULT DATA

Key extender is set to STATION KEY PROGRAMMING (MMC 72) data.

RELATED MMC

MMC 71 SYSTEM KEY PROGRAMMING
MMC 72 STATION KEY PROGRAMMING



**MMC 17****STATION SPEED-DIAL**

This MMC is used to program the personal dial memory assigned to a station. Each station may have up to 20 memory locations, numbered 00 to 19. Each dial number consists of a trunk or trunk group access code followed by a separator (:) and up to 30 digits to be dialed. If you dial a valid trunk or trunk group access number, it will automatically insert the separator.

PROCEDURE**LCD DISPLAY**

1. Press **[TRANSFER]** and dial **17**

2. Using **[VOLUME (-) or (+)]**, select a station (e.g. 202)

3. Press **[REDIAL]** or **[FLASH]** to select the entry.
OR

Dial the entry number (e.g.17)

If the data exceeds 13 digits, press **[SPEED]** to verify the undisplayed data.

Display entry moves left 1 digit at a time

4. Enter station Number, Telephone number, or trunk access code (e.g. 9), followed by the number to be dialed (e.g. 4558971)

OR

Press **[HOLD]** to clear an entry

To make a digit invisible, press **[MUTE] + digit + [MUTE]**.
(e.g. 9 + 455 **[MUTE]** 8 **[MUTE]** 971)

The digit will display as ' '

5. Press **[TRANSFER]** to save and exit

DEFAULT DATA

NONE.

RELATED MMC

NONE

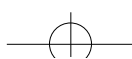



MMC 20

OPEN PROGRAMMING

This MMC is used to open or close Customer or Technician level programming. If programming is not opened and an attempt is made to access a system MMC, the error message [NOT PERMIT] will be displayed. A four-digit Customer passcode is required to access Customer level programming allocated in MMC 90 (Customer MMC Number). Or a four-digit Technician level passcode is required to open all the MMCs.

PROCEDURE

LCD DISPLAY

1. Press **[TRANSFER]** and dial **20**

PASSCODE :

2. Enter passcode
Default passcodes:

1234 for customer level programming

4321 for technician level programming

PASSCODE : ****

3. Press **[MUTE]** or **[MESSAGE]** to select **DISABLE** or **ENABLE**
OR

Dial **0** to select **DISABLE**
or **1** for **ENABLE**

ENABLE

4. Press **[TRANSFER]** to save and exit

DEFAULT DATA

DISABLE

RELATED MMC

CUSTOMER PROGRAMMING: Refer to **MMC 90**

TECHNICIAN LEVEL PROGRAMMING : **ALL MMCs**

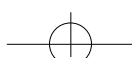

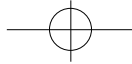
**MMC 21****CHANGE PASSCODE**

Use this MMC to change the passcode allowing access to MMC 20 'Open Programming'.

NOTE: The passcode is four digits long. A digit may be 0 to 9.
The current (old) passcode is required for this MMC.

NOTE: Press **[HOLD]** to reset passcode to default value '1234'.

PROCEDURE**LCD DISPLAY**

1. Press **[TRANSFER]** and dial **21**

2. Enter new passcode via KEYPAD(maximum four digits)
To change customer passcode, first enable the customer program To change technician passcode, you first enable your technician program

3. Display shows

Enter new passcode via KEYPAD

4. If reentered passcode is valid, display will show "SUCCESS"
OR
If invalid, display will show "ERROR"

5. Press **[TRANSFER]** to save and exit

DEFAULT DATA

Customer passcode : 1234
Technician passcode : 4321

RELATED MMC

MMC 20 OPEN PROGRAMMING

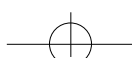

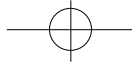

MMC 22

CUSTOMER ON/OFF

This MMC is used to allow the system administrator to set any of the following keyset features:

- BGM** When ON, allows the user to hear background music.
- DND** When ON, allows the user to set the Do Not Disturb feature.
- DOOR** When ON, allows the user to open the door
- HUNT** When ON, an intercom call will be forwarded to the next station of station group to which the station belongs.
- MIKE** When ON, the station can activate the speakerphone.
- PAGE USE** When ON, the station can page.
- PAGE RECEIVE** When ON, the station will receive the paging announcements.
- SMDR** When OFF, information related to the station will not print on the SMDR report.

PROCEDURE

LCD DISPLAY

1. Press [TRANSFER] and dial 22	
2. Using [VOLUME (-) or (+)] , select a station <i>To select all stations, press [VOLUME (-)] first</i>	
3. Press [REDIAL] or [FLASH] to select keyset features listed above	
4. Press [MUTE] or [MESSAGE] to select data OR Using KEYPAD, dial 0 for OFF or 1 for ON	
5. Press [TRANSFER] to save and exit	

DEFAULT DATA

- BGM : ON
- DND : ON
- DOOR : ON
- HUNT : OFF
- MIKE : ON
- PAGE USE : ON
- PAGE RECEIVE : ON
- SMDR : ON

RELATED MMC

- HUNT : **MMC 35 ASSIGN STATION GROUP**
- PAGE USE, PAGE RECEIVE : **MMC 23 PAGE ZONE**
- SMDR : **MMC 81 SMDR OPTION**

Programming 21, 22

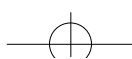

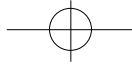

MMC 23

PAGE ZONE

This MMC is used to assign a keyset to one (or none) of the four internal paging zones.

NOTE: Number 5 is external paging and ' * ' assigns to all internal and external paging zones.

PROCEDURE

LCD DISPLAY

1. Press **[TRANSFER]** and dial **23**

201: NO ZONE

2. Using **[VOLUME (-)]** or **[+]**, select a station (e.g. 202)
To select all stations, press [VOLUME (-)] first

202: NO ZONE

3. Press **[MUTE]** or **[MESSAGE]** to select
 OR

Using KEYPAD, dial

0 for **NO ZONE**

1 for **ZONE 1**

2 for **ZONE 2**

3 for **ZONE 3**

or **4** for **ZONE 4** (e.g. ZONE 1)

202: ZONE 1

4. Press **[TRANSFER]** to save and exit

DEFAULT DATA

NO ZONE

RELATED MMC

MMC 22 CUSTOMER ON/OFF
 PAGE USE
 PAGE RECEIVE



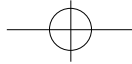

MMC 24

ASSIGN BARGE-IN

This MMC is used to set the type of barge-in permitted at a particular station. After the barge-in type is set, the barge-in class can be set. The barge-in class allows or disallows the user to barge-in on another station.

OPTION	BARGE-IN TYPE	DESCRIPTION
0	NO BARGE-IN	Barge-in feature is unavailable regardless of a station's barge-in status.
1	WITH TONE	Barge-in will produce an intrusion tone and display at the barged-in on station.
2	WITHOUT TONE	Barge-in is allowed. There is no barge-in tone and no display at the barged-in station, and the barge-in station will be muted.

OPTION	BARGE-IN CLASS	DESCRIPTION
00	NN	You cannot barge-in. / Nobody can barge-in on you.
01	NY	You cannot barge-in. / Others can barge-in on you.
10	YN	You can barge-in. / Nobody can barge-in on you.
11	YY	You can barge-in. / Others can barge-in on you.

PROCEDURE

LCD DISPLAY

1. Press [TRANSFER] and dial 24	
2. Pressing [MUTE] or [MESSAGE] to select barge-in type OR Using KEYPAD, dial 0 for NO BARGE IN 1 for WITH TONE or 2 for WITHOUT TONE	
3. Using [VOLUME (-) or (+)] , select a station (e.g. 202) <i>To select all stations, press [VOLUME (-)] first</i>	
4. Using KEYPAD, dial 00 for NN 01 for NY 10 for YN or 11 for YY You can select barge-in class (NN, NY, YN, YY)	
5. Press [TRANSFER] to save and exit	

DEFAULT DATA

BARGE-IN TYPE : NO BARGE IN
BARGE-IN CLASS : NN

RELATED MMC

NONE

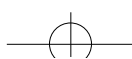



MMC 25

HOT/WARM LINE

This MMC is used to assign a hot line/prime line destination to a station.

The destination may be any of the following:

- Station Number**
- Station Group Number**
- Trunk Number**
- Trunk Group Number**
- Speed-Dial location (00 to 99)**

The **Warm Line** Delay Time is also assigned by this MMC.

PROCEDURE

LCD DISPLAY

1. Press [TRANSFER] and dial 25	
2. Using KEYPAD, select the destination (e.g. 233)	
3. Enter a single digit for the Warm Line Delay Time (0 - 9 Sec)	
4. Press [TRANSFER] to save and exit	

DEFAULT DATA

DESTINATION : NONE
WARM LINE DELAY TIME : 0 SEC

RELATED MMC

NONE



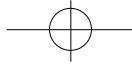

MMC 26

ALARM REMINDER

This MMC allows the system administrator or technician to set or change the alarm clock/appointment reminder feature for any station. Three alarms may be set for each station, and each alarm may be defined as a "DAY" alarm or as a "DAILY" alarm. The DAY alarm is automatically canceled after it rings, while the DAILY alarm rings every day at the same time.

PROCEDURE

LCD DISPLAY

1. Press [TRANSFER] and dial 26	201 A1:HHMM:DAY
2. Use [VOLUME (-) or (+)] , select a station (e.g. 202)	202 A1:HHMM:DAY
3. Press [REDIAL] or [FLASH] to select an alarm number (1~3).	202 A2:HHMM:DAY
4. Dial the alarm time. The time is entered in 24 hour format (0000 is 12:00 midnight) <i>To clear alarm data, press [HOLD]</i>	202 A2:2030:DAY
5. Press [MUTE] or [MESSAGE] to select an alarm mode	202 A2:2030:DAILY
6. Press [TRANSFER] to save and exit	

DEFAULT DATA

ALARM MODE : DAY MODE

ALARM1 : HHMM DAY

ALARM2 : HHMM DAY

ALARM3 : HHMM DAY

RELATED MMC

MMC 55 CURRENT DATE AND TIME



**MMC 27****VACANT MESSAGE**

The system provides up to 20 vacant messages that can be selected by any display keypad user. Messages 01 through 10 are pre-programmed, as shown below. Messages 11 through 20 may be customized via this MMC. The selected message will appear in the display of any calling station.

NO.	MESSAGE
01	IN A MEETING
02	OUT ON A CALL
03	OUT TO LUNCH
04	LEAVE A MESSAGE
05	PAGE ME
06	OUT OF TOWN
07	IN TOMORROW
08	RETURN AFTERNOON
09	ON VACATION
10	GONE HOME

PROCEDURE**LCD DISPLAY**

1. Press [TRANSFER] and dial 27	
2. Use [VOLUME (-) or (+)] to select the desired message number (11-20)	
3. Enter the message text <i>Refer to MMC 14</i>	
4. Press [TRANSFER] to save and exit	

DEFAULT DATA

NONE

RELATED MMC

MMC 14 STATION NAMES





MMC 28

CALL DISC

Used to assign the incoming and outgoing call disconnection per station.
There are four different option.

- 0 No Disconnection
- 1 Out Only
- 2 In Only
- 3 Both

PROCEDURE

LCD DISPLAY

1. Press **[TRANSFER]** and dial **28**

201: NO DISC

2. Using **[VOLUME (-)]** or **[+]**, select the station you want
(e.g. 202)
*If you want to select all station, press **[VOLUME (-)]** first.*

202: NO DISC

3. Press **[MUTE]** or **[MESSAGE]** in several times,
you can make selection
OR
Using **KEYPAD**, dial
0 for No Disconnection
1 for Out Only
2 for In Only
or **3 for both**(e.g., 3)

202: BOTH

4. Press **[TRANSFER]** to save and exit

DEFAULT DATA

NO DISC

RELATED MMC

MMC 50	SYSTEM TIMERS TRK DISC
MMC 42	TRUNK ON/OFF TRK DISC

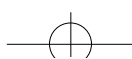

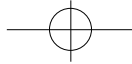

MMC 30

STATION TOLL CLASS

This MMC is used to assign any of the 6 different day and/or night class of service to each station, as per the table below:

DIAL DIGIT	TOLL CLASS	DESCRIPTIONS
1	A	No restriction
2	B	Follow allow/deny table for each class
3	C	Follow allow/deny table for each class
4	D	Follow allow/deny table for each class
5	E	Follow allow/deny table for each class
6	F	Intercom call only

PROCEDURE

LCD DISPLAY

1. Press **[TRANSFER]** and dial **30**

201: AA

2. Using **[VOLUME (-)]** or **[+]**, select a station (e.g. 202)
To select all stations, press [VOLUME (-)] first

202: AA

3. Dial 1~6 (e.g. 2 3) (two digits, the first for Day and the second for Night class), to select A~F class as per table above. Display shows A~F class

202: BC

4. Press **[TRANSFER]** to save and exit

DEFAULT DATA

DAY CLASS : A
 NIGHT CLASS : A

RELATED MMC

MMC 60 TOLL DENY TABLE/APPLY
 MMC 61 TOLL ALLOW TABLE/APPLY



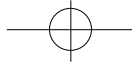

MMC 31

EXT/TRK USE

This MMC is used to allow trunks the ability to answer incoming calls, to dial out, or to do both, on a per-station basis. Those abilities are displayed as Y or N for each action (e.g. NY: disallow dialing out and allow answering incoming calls).

DIAL DIGIT	TRK USE	DESCRIPTION
00	NN	You cannot either dial and answer
01	NY	You cannot dial but can answer
10	YN	You can dial but cannot answer
11	YY	You can both dial and answer

PROCEDURE

LCD DISPLAY

1. Press **[TRANSFER]** and dial **31**

201: USE 701 :YY

2. Using **[VOLUME (-) or (+)]**, Select a station (e.g. 202)
*To select all stations, press **[VOLUME (-)]** first*

202: USE 701 :YY

3. Select trunk number by pressing **[REDIAL]** or **[FLASH]** repeatedly
*To select all trunks, press **[REDIAL]** first*

202: USE 702 :YY

4. You can select NN, NY, YN or YY stations (e.g., NY)
 Using KEYPAD,
0 for deny the action
1 for allow the action
 (Two digits must be dialed. First digit for dialing out,
 and second for answering incoming calls.)

202: USE 702 :NY

5. Press **[TRANSFER]** to save and exit

DEFAULT DATA

ALL TRUNK : YY

RELATED MMC

NONE

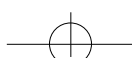

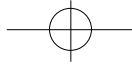

MMC 32

INTERCOM USE

This MMC is used to allow/disallow station intercom calls.

PROCEDURE

LCD DISPLAY

1. Press **[TRANSFER]** and dial **32**

2. Use **[VOLUME (-)]** or **[+]**, to select a station (e.g. 202)
To select all stations, press [VOLUME (-)] first

3. Press **[REDIAL]** or **[FLASH]** to select call station
 (e.g. ALL)
To select all stations, press [REDIAL] first

4. Press **[MUTE]** or **[MESSAGE]** to select the
 allow/disallow option (e.g. disallow all intercom calls)
 OR

Using KEYPAD, dial

0(N) for disallow intercom call

1(Y) for allow intercom call

*If you set N, intercom calls are not possible,
 calling the operator is possible*

5. Press **[TRANSFER]** to save and exit.

DEFAULT DATA

CALL ALL : Y

RELATED MMC

NONE

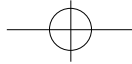

**MMC 33****ASSIGN DOOR RING**

This MMC is used to designate which devices (station or station group) will ring when a door box button is pressed.

PROCEDURE**LCD DISPLAY**

1. Press **[TRANSFER]** and dial **33**
Display shows designated stations or station groups for DOOR1 (day and night)



DOOR1 D:500 N:500

2. Press **[VOLUME (-) or (+)]** to select DOOR 1 or DOOR 2



DOOR2 D:500 N:500

3. Enter new DAY/NIGHT selection via dial keypad
(e.g. 501 for day, and 201 for night)

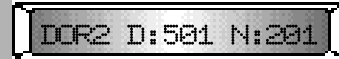

DOOR2 D:501 N:201

4. Press **[TRANSFER]** to save and exit.

DEFAULT DATA

DOOR1: DAY: 500 NIGHT: 500
DOOR2: DAY: 500 NIGHT: 500

RELATED MMC

NONE

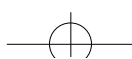



MMC 34

ASSIGN PICKUP GROUP

This MMC is used to allow the assignment of stations to call pickup groups. There may be a maximum 10 pickup groups (0~9). An unlimited number of members can belong to each group. Stations can be in only one pickup group at any given time.

PROCEDURE

LCD DISPLAY

1. Press **[TRANSFER]** and dial **34**
Display shows the first member of pickup group 0

2. Using **[VOLUME (-) or (+)]**, select a pickup group number (e.g. GPC1)

3. Press **[REDIAL]** or **[FLASH]** to scroll through the members of the selected pickup group

4. Dial station number
*If dialed number is the member of another pickup group, the station number will removed from the previous group automatically.
Dialed number overwrites the previous number.*

5. Press **[TRANSFER]** to save and exit

DEFAULT DATA

[GPC0] : All stations
[GPC1] [GPC9] : NONE

RELATED MMC

NONE



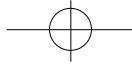

MMC 35

ASSIGN STATION GROUP

This MMC is used to assign members of a station group. There are several options that can be selected for ringing, overflow, group transfer and overflow destination, and group type. There may be a maximum twenty (20) groups.

OPTIONS	DISPLAY	RANGE
Ring mode	RING	
Overflow time	OVER	000 250 sec
Group transfer time	TRSF	000 250 sec
Overflow port	NEXT	
Group types	TYPE	

RING MODES	DESCRIPTION
1 SEQUENTIAL	The first idle station listed in the group will ring. If the first is busy, the next idle station will ring.
2 DISTRIBUTE	The first call will ring the first station listed in the group. The next call will ring the next station listed in the group.
3 CONDITION	All the stations but non-busy stations listed in the group will ring.
4 UNCONDITION	All the stations listed in the group will ring. Busy stations will receive off-hook ring.

GROUP TYPES	
1	NORMAL GROUP
2	VMAA GROUP

PROCEDURE

LCD DISPLAY

1. Press [TRANSFER] and dial 35 <i>Display shows ring mode of Operator group 500.</i>	
2. Using [VOLUME (-) or (+)] , select a station group number (500 519).	
3. Press [REDIAL] or [FLASH] to select options (RING, OVER, TRSF, NEXT, TYPE, MEMBER)	
4a. Press [MUTE] or [MESSAGE] to select ring mode OR Dial 1 for SEQUENTIAL 2 for DISTRIBUTE 3 for CONDITION or 4 for UNCONDITION	
4b. To change the OVERFLOW TIME, enter 3 digits of OVERFLOW TIME	
4c. To change the GROUP TRANSFER TIME, dial 3 digits of GROUP TRANSFER TIME	

Programming 34, 35

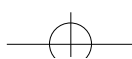

NX-SERIES HYBRID KEY SYSTEM

PROGRAMMING SECTION

MMC 35

4d. To assign the overflow port, enter the station or station group number.

500: NEXT: 501

4e. Press **[MUTE]** or **[MESSAGE]** to select the station group type
OR

500: TYPE: NORMAL

Using KEYPAD,

1 for NORMAL GROUP

2 for VMAA GROUP

4f. To assign a member to the station group, enter the station number.

500: MEM1: 201

If dialed number is the member of another station group, the station number will be removed from the previous group automatically.

Dialed number overwrites the previous number.

5. Press **[TRANSFER]** to save and exit

DEFAULT DATA

RING	: DIST
OVERFLOW	: 030 SEC
TRANSFER TIME	: 045 SEC
TYPE	: NORMAL GROUP
MEMBER	: 201
GROUP	: 500
OTHER GROUP	: NONE

RELATED MMC

MMC 22 CUSTOMER ON/OFF
HUNT



**MMC 36****ASSIGN BOSS/SECRETARY**

This MMC is used to assign BOSS keysets to SECRETARY keysets. One SECRETARY station may include two (2) BOSS stations.

PROCEDURE**LCD DISPLAY**

1. Press **[TRANSFER]** and dial **36**

S201 1: 2:

2. Using **[VOLUME (-) or (+)]**, select the SECRETARY station (e.g. 202)
*Display shows the **BOSS** stations*

S202 1: 2:

3. Enter the **BOSS** stations
(e.g. BOSS1: 220, BOSS2: 230)

S202 1:220 2:230

4. Press **[TRANSFER]** to save and exit

DEFAULT DATA

BOSS1: NONE

BOSS2: NONE

RELATED MMC

NONE

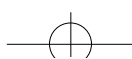

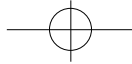
**MMC 37****ASSIGN ADD-ON MODULE**

This MMC is used to assign an add-on module (AOM) to a station.

PROCEDURE**LCD DISPLAY**

1. Press **[TRANSFER]** and dial **37**
Display shows the first AOM port

205: MASTER:

If there is no AOM port, display shows:

AOM NOT EXIST

2. Press **[VOLUME (-) or (+)]**, to select the AOM port
*To clear any previous entry, press **[HOLD]***

206: MASTER:

3. Enter master station number

206: MASTER:204

4. Press **[TRANSFER]** to save and exit

DEFAULT DATA

NONE

RELATED MMC

NONE



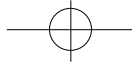

MMC 38

SLT DIALING TYPE

This MMC is used to define the dial type of phone connected to each SLT port.

Keysets are not affected by this MMC.

There are two dialing types:

DIALING TYPES

- 1 **DTMF** Dual Tone Multi-Frequency (Touch Tone)
- 2 **PULSE** Dial Pulse (rotary)

PROCEDURE

LCD DISPLAY

1. Press **[TRANSFER]** and dial **38**
Display shows the SLT port (e.g. 217)

217: DTMF

If there is no SLT port, display shows

SLT NOT EXIST

2. Using **[VOLUME (-)]** or **[+]**, select the SLT port number
To select all stations, press [VOLUME (-)] first

218: DTMF

3. Press **[MUTE]** or **[MESSAGE]** to select the SLT type.
OR
Using KEYPAD, dial
1 for DTMF
or **2 for PULSE**

218: PULSE

4. Press **[TRANSFER]** to save and exit

DEFAULT DATA

DTMF

RELATED MMC

NONE

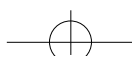

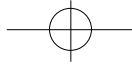
**MMC 39****DATA LINE**

Used to assign SLT ports to be used for data transmission.

- VOICE** - The station will be used for voice communication. All intrusion and warning tones will be heard during conversation.
- DATA** - The station will be used for data communication. No intrusion or warning tones will occur during data transmission.

PROCEDURE**LCD DISPLAY**

1. Press **[TRANSFER]** and dial **39**

2. Display shows.(e.g. 209 is SLT port)

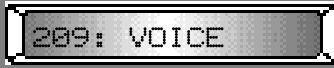

209: VOICE

3. Using **[VOLUME (-)]** or **[+]**, select the SLT port number.
*To select all SLT ports, press **[VOLUME (-)]** first*



210: VOICE

4. Press **[MUTE]** or **[MESSAGE]** to select VOICE or DATA
The port is set to DATA line.



210: DATA

OR

Dial

1 for VOICE
or **2 for DATA**

5. Press **[TRANSFER]** to save and exit

DEFAULT DATA

VOICE line

RELATED MMC

NONE

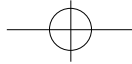

**NX-SERIES** HYBRID KEY SYSTEM

PROGRAMMING SECTION

MMC 40**C.O./PBX LINE**

This MMC is used to select the mode of the C.O. line. If the PBX mode is chosen, the PBX access code can be recognized allowing more complete toll restrictions. This mode is assigned on a per-trunk basis.

PROCEDURE**LCD DISPLAY**

1. Press **[TRANSFER]** and dial **40**



2. Using **[VOLUME (+)]** or **[VOLUME (-)]**, select the trunk number (e.g. 702)
To select all trunk lines, press **[VOLUME (-)]** first



3. Pressing **[MUTE]** or **[MESSAGE]**, you can set the trunk to C.O. or PBX line
OR
Using KEYPAD, dial
1 for C.O line
or **2 for PBX line**



4. Press **[TRANSFER]** to save and exit

DEFAULT DATA

C.O. LINE

RELATED MMC

NONE

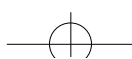

**MMC 41****TRUNK DIALING TYPE**

This MMC is used to set the dial type of each C.O. line.

There are two options:

- DTMF** : Dual Tone Multi Frequency (Touch Tone)
PULSE : Pulse dial (rotary).

PROCEDURE**LCD DISPLAY**

1. Press **[TRANSFER]** and dial **41**

701: DTMF

2. Using **[VOLUME (-)]** or **[+]**, select the trunk number
*To select all trunk lines, press **[VOLUME (-)]** first*

702: DTMF

3. Press **[MUTE]** or **[MESSAGE]** to select the trunk dial type
OR
Using KEYPAD, dial
1 for DTMF
or **2 for PULSE**

702: PULSE

4. Press **[TRANSFER]** to save and exit

DEFAULT DATA

DTMF

RELATED MMC

MMC 53 TRUNK WIDE TIMER
MMC 54 MAKE/BREAK RATIO



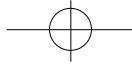

MMC 42

TRUNK ON/OFF

This MMC is used to assign trunk options on a per-trunk basis.

OPTION	DESCRIPTION
1A2 EMULATION	Trunk override call
TRUNK FORWARD	Allow trunk to be forwarded
RING OVER PAGE	Allow ring over external page
TOLL CHECK FREE	C.O. lines to follow or bypass toll restriction
VOICE MSG	Voice announcement on DISA line
TRK DISC	Allows trunk to be disconnected

PROCEDURE

LCD DISPLAY

1. Press [TRANSFER] and dial 42	
2. Using [VOLUME (-) or (+)] , select trunk number To select all trunks, press [VOLUME(-)] first	
3. Using [REDIAL] or [FLASH] , select an option described above	
4. Press [MUTE] or [MESSAGE] to select ON or OFF. OR Using the KEYPAD, dial 0 for OFF or 1 for ON	
5. Press [TRANSFER] to save and exit	

DEFAULT DATA

1A2 EMULATION	: OFF	TRUNK FORWARD	: OFF
RING OVER PAGE	: OFF	TOLL CHECK FREE	: OFF
VOICE MSG	: OFF	TRK DISC	: OFF

RELATED MMC

TRUNK FORWARD	: MMC 11 CALL FORWARD
VOICE MSG	: MMC 46 ASSIGN DISA LINE
TRK DISC	: MMC 50 SYSTEM TIMER(TRK DISC) MMC 28 CALL DISC

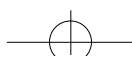

**MMC 43****ASSIGN TRUNK RING**

A trunk may have a maximum 16 members(station or station group) assigned to ring.

PROCEDURE**LCD DISPLAY**

1. Press [TRANSFER] and dial 43	
2. Using [VOLUME (-) or (+)] , select the trunk you want (e.g., 703)	
3. Press [REDIAL] or [FLASH] , select the options (RING MODES, DAY MEMBERS or NIGHT MEMBERS) (e.g., RING MODES)	
4a. Press [MUTE] or [MESSAGE] , to select ring mode OR Dial 1 for SEQUENTIAL 2 for DISTRIBUTE 3 for CONDITION or 4 for UNCONDITION (e.g., UNCONDITION)	
4b. Dial the station or station group number that will be ringing to(e.g., 500 for the first memver of Day mode)	
5. Press [TRANSFER] to save and exit	

DEFAULT DATA

All trunks Day1 :500
 Night1 :500

RELATED MMC

MMC 35 ASSIGN STATION GROUP
MMC 56 ASSIGN AUTO NIGHT TIME





MMC 44 TRUNK NAMES

This MMC is used to assign a name of up to twelve (12) characters to identify a particular trunk.



Names are written using the keypad. Each press of a key will select a character. Pressing a different key moves the cursor to the next position.

Dial Count	1	2	3	4	5	6	7	8	9	0	*	#
1	Q	A	D	G	J	M	P	T	W	:	?	
2	Z	B	E	H	K	N	R	U	X	.	&	[
3		C	F	I	L	O	S	V	Y	!	\$]
4	1	2	3	4	5	6	7	8	9	0	*	#

NOTE : When the next character appears on the same dial pad key as the current character, press **[FLASH]** to move the cursor to the right, or to enter a space.

PROCEDURE

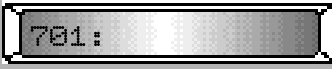
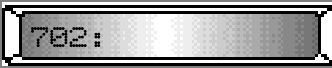
LCD DISPLAY

- 1. Press **[TRANSFER]** and dial **44** 
- 2. Press **[VOLUME (-) or (+)]** to select the trunk to name 
- 3. Enter the trunk name(refer to above chart) 
- 4. Press **[TRANSFER]** to save and exit

DEFAULT DATA

NONE

RELATED MMC

NONE

Programming 43, 44



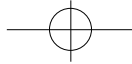

MMC 45

TRUNK GROUP

This MMC is used to set the free trunk selection type to a specific trunk, trunk group, or to several trunk groups.

There are eleven (11) trunk groups: 9 and 80 through 89, and three types of selecting a free trunk line in the group.

MODE	DESCRIPTION
DISTRIBUTE	Searches the trunk group in circular order. Each time the group is accessed, the next available trunk in the group is selected.
High to Low	Searches the trunk group last to first trunk in the group. If a trunk is busy, the previous available trunk in the group is selected.
Low to High	Searches the trunk group. If the first trunk in the group is busy, the next available trunk in the group is selected.

PROCEDURE

LCD DISPLAY

1. Press [TRANSFER] and dial 45 <i>Display shows the first free trunk selection type</i>	
2. Using [MUTE] or [MESSAGE] , select the free trunk selection mode OR Using KEYPAD , dial 1 for DISTRIBUTE 2 for High to Low or 3 for Low to High .	
3. Using [VOLUME (-) or (+)] , select the trunk group	
4. Press [REDIAL] or [FLASH] to scroll through the group <i>If dialed number is the member of another trunk group, the trunk number will removed from the previous group automatically. Dialed number overwrites the previous number.</i>	
5. Enter a valid trunk number	
6. Press [TRANSFER] to save and exit	

DEFAULT DATA

GROUP 9	: All trunk lines
GROUP 80~89	: NONE

RELATED MMC

NONE

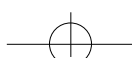

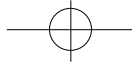

MMC 46

ASSIGN DISA LINE

This MMC is used to allow the system the ability to have Direct Inward System Access (DISA). There are four DISA. If a trunk is set to DISA, the voice announcement feature may be used when the VOICE MSG option is enabled in MMC 42 TRUNK ON/OFF.

OPTIONS	DESCRIPTION
0 NO DISA LINE	No DISA service
1 DISA IN NIGHT MODE	In night mode, DISA is available
2 DISA IN DAY MODE	In day mode, DISA is available
3 DISA BOTH NIGHT AND DAY	In day and night mode, DISA is available

PROCEDURE

LCD DISPLAY

1. Press **[TRANSFER]** and dial **46**
Display shows

701: NO DISA

2. Using **[VOLUME (-) or (+)]**, select the trunk you want
 (e.g. 702)
To select all trunks, press [VOLUME (-)] first

702: NO DISA

3. Press **[MUTE]** or **[MESSAGE]** to select
 OR
 Using KEYPAD, dial
0 for NO DISA LINE
1 for DISA IN NIGHT MODE
2 for DISA IN DAY MODE
3 for DISA BOTH NIGHT AND DAY
 (e.g. 1)

702: NIGHT DISA

4. Press **[TRANSFER]** to save and exit

DEFAULT DATA

All trunks : NO DISA

RELATED MMC

MMC 42 TRUNK ON/OFF VOICE MSG

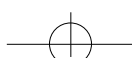

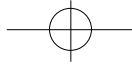

MMC 50

SYSTEM TIMERS

This MMC is used to adjust individual timers as necessary. All available timers are described in the **TABLE OF TIMERS AND VALUES**.

NOTE: Seconds are shown as 'SEC', milliseconds as 'MS', and minutes as 'MIN'.

PROCEDURE

LCD DISPLAY

1. Press **[TRANSFER]** and dial **50**

2. Press **[VOLUME (-) or (+)]** to select a timer
(e.g. ALM R DUR)

3. Enter new value using KEYPAD

4. Press **[TRANSFER]** to save and exit

DEFAULT DATA

See TABLE OF TIMERS AND VALUES

RELATED MMC

NONE

TABLE OF TIMERS AND VALUES

DISPLAY	DESCRIPTION	DEFAULT	RANGE
ALM R INT (Alarm ring interval)	controls the time length between ring attempts at a station when alarm reminder is set.	025SEC	250SEC
ALM R DUR (Alarm ring duration)	controls the length of ring cycle duration when alarm reminder is set at a station.	010SEC	1~250SEC
ARDL INT (Auto Redial interval)	controls the time between attempts after Auto Redial is set 'ON' at a station.	045SEC	1~250SEC
ARDL RELS (Auto Redial release time)	controls the duration of a Ring No Answer condition on an auto-redial number dialed before auto redial is canceled.	045SEC	1~250SEC
CBACK NOA (Callback no answer time)	controls the time before the callback is canceled when a callback detects Ring No Answer	030SEC	1~250SEC
CO CO DIS (CO to CO disconnect time)	monitors the duration of an unsupervised conference, external call forward, or DISA call. upon expiring, both trunks are disconnected.	010MIN	1~250MIN
DISA F DG	controls how long the system will wait for dialing to begin the DISA incoming call.	025SEC	1~250SEC
DISA I DG	controls the grace period between dialing valid digits before dropping the call to DISA user.	025SEC	1~250SEC
DISA RING	controls no answer time for DISA internal calling.	030SEC	1~250SEC
DOOR RELS (Door release time)	controls the duration of time before the door lock relay deactivates.	1500MS	100~2500MS

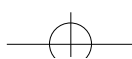

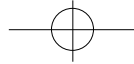

NX-SERIES HYBRID KEY SYSTEM

PROGRAMMING SECTION

MMC 50

DISPLAY	DESCRIPTION	DEFAULT	RANGE
DOR R OFF (Door Ring OFF time)	controls the duration of ringing at the door ring destination before canceling	030SEC	1~250SEC
FIRST DGT (First Digit wait time)	controls how long the system will wait for dialing to begin before dropping the dial tone and initiating an error tone.	025SEC	1~250SEC
HOOK OFF (Hook OFF time)	controls the time before dial tone is sent to a single-line station.	0200MS	100~2500MS
INTER DGT (Inter Digit duration)	controls the grace period between dialing valid digits before dropping the call and returning the user back to an error tone.	025SEC	1~250SEC
MMC OUT (MMC session time)	controls the grace period between programming actions while in a programming session, before returning system to secure programming status.	030SEC	10~250SEC
OFF R INT (Off hook Ring Interval)	controls the duration of time between ring bursts to a user who has a camped-on call.	015SEC	1~250SEC
PAGE MAX (Page duration)	controls the allowed duration of a page announcement.	020SEC	1~250SEC
RCAL DISC (Recall Disconnect time)	this is the time an attendant recall will ring before being disconnected.	002MIN	1~250MIN
RCAL RING (Recall Ring length)	this is the length of time a transfer recall will ring at a station before recalling the operator	015SEC	0~250SEC
RCAL WAIT (Recall Waiting time)	after a transferred call is recalling at the transferring station and the station is busy, this timer will expire and transfer the call to the operator. This only applies to trunk calls.	015SEC	0~250SEC
RCAL HOLD (Recall Hold time)	determines the time calls can be left on hold before recalling back to the holding station.	045SEC	0~250SEC
RCAL TRSF (Recall Transfer time)	determines the time transferred calls ring before recalling.	045SEC	0~250SEC
SLT F MIN (minimum SLT Flash time)	monitors the duration of a hookswitch flash to ensure that the flash is valid and not a line transient or accidental hookswitch bounce. It is the minimum time of single-line station.	0350MS	100~2500MS
SLT F MAX (maximum SLT flash time)	maximum time of hookswitch flash of a single-line station.	0800MS	100~2500MS
SMDR PULS (SMDR start time for rotary dialing)	this grace period timer starts SMDR recording for pulse (rotary) dialing and controls the LCD duration timer on the keysets.	030SEC	1~250SEC
SMDR DTMF (SMDR start time for touchtone dialing)	this grace period timers starts SMDR recording for DTMF (Touch Tone) dialing and controls the LCD duration timer on the keysets.	015SEC	1~250SEC
TRK DISC	controls the duration of an outside call	030MIN	1~250MIN

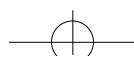



MMC 51

TONE/RING CADENCE

This MMC is used to customize the tone cadence on a system-wide basis to any one of the eight available selections.

Call Technical Support before changing any cadences, as some systems may require default settings.

PROCEDURE

LCD DISPLAY

1. Press **[TRANSFER]** and dial **51**
Display shows

DT: CONTINUOUS

2. Press **[VOLUME (-) or (+)]** to select a tone

RBT: 1000200010002000

3. Press **[MUTE]** or **[MESSAGE]** to set dial tone to continuous or interrupted tone

DT: 1000025010000250

Interrupt tone default data is: 1000 0250 1000 0250 ms

4. Dial new interrupt value for interrupt time, (ON/OFF/ON/OFF) in 50 ms steps.
Each field is 3 digits (UNIT: 10 ms)
(e.g. 100/030/100/030 = 1000 ms [100 × 10] 'ON' and 300 ms [030 × 10] 'OFF' time)

RBT: 1000030010000300

5. Press **[TRANSFER]** to save and exit

DEFAULT DATA

TONE NAME	DISPLAY	DATA
DIAL TONE	(DT)	CONTINUOUS TONE
RING BACK TONE	(RBT)	1000 2000 1000 2000 ms
BUSY TONE	(BST)	0500 0500 0500 0500 ms
TRSF TONE	(TT)	0200 0200 0200 0200 ms
ERROR TONE	(ERT)	0500 0250 0500 0250 ms
CO LINE RING	(COR)	1000 3000 1000 3000 ms
STATION RING	(STR)	0400 0200 0400 3000 ms

RELATED MMC

NONE



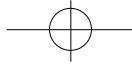

MMC 52

SYSTEM WIDE COUNTER

This MMC is used to set the values of the system counters.

The counters and descriptions are listed below:

OPTIONS	DESCRIPTION
ALM COUNTER (ALARM REMINDER COUNTER)	This is the number of times (1 to 99) that an alarm reminder will ring a station before canceling.
ARDL COUNTER (AUTO REDIAL COUNTER)	This is the number of times (1 to 99) the system will redial an outside number after the auto redial feature has been activated.

PROCEDURE

LCD DISPLAY

1. Press [TRANSFER] and dial 52 Display shows:	
2. Press [VOLUME (-) or (+)] to select a counter	
3. Use keypad to enter new data as a two-digit number (e.g. 5 = 05)	
4. Press [TRANSFER] to save and exit	

DEFAULT DATA

ALM COUNTER : 3
ARDL COUNTER : 10

RELATED MMC

NONE

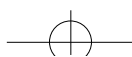



MMC 53

TRUNK WIDE TIMER

This MMC is used to changed trunk timer values. It is not advisable to change these values, with exception of trunk flash time, without assistance from Technical Support. The available options are and listed below:

DISPLAY	DESCRIPTION	RANGE
CLEARING (clearing time)	The interval for reuse of trunk after disconnecting a call.	0~25sec
CO SUPV (CO supervision time)	C.O. checking	00~9000 msec
F DGT DLY (first digit delay time)	After seizing a trunk line, system sends the first digit after this time.	100~2500 ms
FLASH PBX (PBX flash time)	The duration of a flash when connected to a C.O.	100~2500 ms
MFS ON TM (MF sender on time)	The duration of DTMF Sender 'ON' status when sending DTMF signal.	100~2500 ms
MF OFF TM (MF sender off time)	The interval of DTMF Sender 'OFF' when system sends DTMF signal.	100~2500 ms
MPD DETCT (MPD detect time)	The minimum duration of MPD signal when the signal is incoming.	40~500 msec
NEW CALL (New Call time)	The duration of a flash sent to the central office to disconnect the line.	100~9900 ms
NO RING (no ring time)	if an incoming call is detected and is disconnected without call processing, the system and releases the C.O line.	1~25sec
PAUSE TM (pause time)	This is a dialing pause duration timer. A pause is an instruction for the system to wait.	1~25sec
RNG DETCT (ring detect time)	Must be set shorter than the 'ON' cycle of a C.O. ring to prevent transient noise on the C.O. line from triggering a false ring.	100~2500 ms

NOTE : Seconds shown as 'sec', milliseconds as 'ms', and minutes as 'mi'.

PROCEDURE

LCD DISPLAY

1. Press [TRSF/ALM] and dial 53 Display shows	
2. Press [VOLUME (-) or (+)] to select a timer (e.g. CO SUPV)	
3. Dial new time data(e.g. 0500)	
4. Press [TRSF/ALM] to save and exit	

DEFAULT DATA

CLEARING	: 00 SEC	CO SUPV	: 0000 MSEC
F DGT DLY	: 1000 MSEC	FLASH PBX	: 0600 MSEC
MFS ON TM	: 0100 MSEC	MF OFF TM	: 0100 MSEC
MPD DETCT	: 0060 MSEC	NEW CALL	: 2000 MS
NO RING	: 05 SEC	PAUSE TM	: 03 SEC
RNG DETCT	: 0200 MSEC		

RELATED MMC NONE

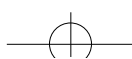

**MMC 54****MAKE/BREAK RATIO**

This MMC is used to allow the ability to change the duration of the make/break time of pulse (rotary) dial trunks.

PROCEDURE**LCD DISPLAY**

1. Press **[TRANSFER]** and dial **54**

2. Enter the MAKE/BREAK ratio on the KEYPAD
(e.g. MAKE:40 BREAK:60)

3. Press **[TRANSFER]** to save and exit

DEFAULT DATA

MAKE : 33
BREAK : 66

RELATED MMC

MMC 41 TRUNK DIALING TYPE

MMC 55**CURRENT DATA AND TIME**

This MMC is used to set the system date and time on the system-wide clock.

YY	Year	00~99 (e.g. 1995 = 95)
MM	Month	01~12
DD	Date	01~31
W	Day	0~6 (0:SUN 1:MON 2:TUE 3:WED 4:THU 5:FRI 6:SAT)
HH	Hour	00~23
MM	Minute	00~59

PROCEDURE**LCD DISPLAY**

1. Press **[TRANSFER]** and dial **55**
Display shows

2. Enter current date and time using above table
display = 1995. 7. 5. Wednesday, 11:35

3. Press **[TRANSFER]** to save and exit

DEFAULT DATA

SAT 01 JAN 12:00

RELATED MMC

MMC 15 DATE DISPLAY



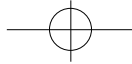

MMC 56

ASSIGN AUTO NIGHT TIME

This MMC is used to automatically place the system in Night mode. A Night key is not needed, as the system switches automatically, but it is helpful to have a dedicated button so the status can be changed manually. 'D' in the display is the time the system will switch from Night to Day service and 'N' is the time the system will switch from Day to Night service. There are three types of automatic Night timetables (WEEK, SATURDAY, SUNDAY), each composed of two time settings.

Table type	Description
WEEK	Monday through Friday
SATURDAY	Saturday
SUNDAY	Sunday

PROCEDURE

LCD DISPLAY

1. Press **[TRANSFER]** and dial **56**
Display shows

2. Press **[VOLUME (-) or (+)]** to select a timetable
There are six tables available (WEEK1, WEEK2, SAT.1, SAT.2, SUN.1, SUN.2)
To switch to Night mode twice a day, you must enter both times in related tables. (e.g. WEEK1 and WEEK2; SAT.1 and SAT.2)
If it is not, the system will switch to the night mode once a day.

3. Enter the Day mode start time, then the Night mode start time.
Eight digits must be entered. If there are less than eight digits, data will not change.

- 3a. To switch twice a day, you must enter data in both related tables (e.g. WEEK1 and WEEK2)

AND

4. Press **[TRANSFER]** to save and exit

DEFAULT DATA

DAY : 0000
NIGHT : 0000

RELATED MMC

NONE

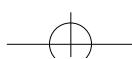

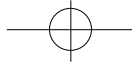
**MMC 57****CALL COST**

This MMC is used to program the unit cost of the metering pulse generated by the Central Office. If the MPD card is installed, it will detect the metering pulse provided by Central Exchange and determine the call cost by the number of metering pulses and unit cost programmed via this MMC. The unit cost is a four (4) digit number, and is measured in the minimum money denomination in the country of use.

PROCEDURE**LCD DISPLAY**

1. Press **[TRANSFER]** and dial **57**
Display shows

2. Enter the 4-digit unit cost.
If you don't enter 4 digits, the existing data will not be changed.

3. Press **[TRANSFER]** to save and exit

DEFAULT DATA

UNIT COST : 0000
(The range of the CALL COST is 0001 ~ 9999)

RELATED MMC

NONE

MMC 60**TOLL DENY TABLE/APPLY**

This MMC enables you to define which leading digit(s) in a dialing plan are to be restricted and which class(es) should be applied in this toll deny table. Each entry can define up to 11 digits.

PROCEDURE**LCD DISPLAY**

1. Press **[TRANSFER]** and dial **60**

2. Press **[MUTE]** or **[MESSAGE]** select the search class
(search class = NEW, ALL, B,C,D,E)

3. Press **[VOLUME (-) or (+)]**, to find the desired entry or an empty entry

4. Enter the dial number to be restricted and press **[CALLBACK]**
to assign the toll restriction apply class And dial four(4) digits,
0 for NO **1 for YES**

5. Press **[TRANSFER]** to save and exit

DEFAULT DATA

NONE

RELATED MMC

MMC 30 STATION TOLL CLASS
MMC 61 TOLL ALLOW TABLE/APPLY
MMC 65 ASSIGN WILD CHARACTER

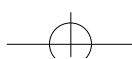

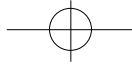
**MMC 61****TOLL ALLOW TABLE/APPLY**

This MMC enables you to define which leading digit(s) in a dialing plan are to be allowed and which class(es) should be applied in this allow table. Each entry can define up to 11 digits.

PROCEDURE**LCD DISPLAY**

1. Press **[TRANSFER]** and dial **61**

TOLL ALLOW: NEW

2. Press **[MUTE]** or **[MESSAGE]** select search class

05464602834:1111

3. Pressing **[VOLUME (-) or (+)]**, you can find the desired entry or empty entry

:BCDE

4. Enter the dial number to be allowed and press **[CALLBACK]** to assign the toll class And dial four(4) digits,
0 for NO
1 for YES

0546 :0011

5. Press **[TRANSFER]** to save and exit

DEFAULT DATA

NONE

RELATED MMC

MMC 30 STATION TOLL CLASS
 MMC 60 TOLL DENY TABLE/APPLY
 MMC 65 ASSIGN WILD CHARACTER

MMC 62**PBX ACCESS CODE**

This MMC is used to identify PBX access codes for toll restriction purposes. When a PBX line is accessed, the dial tone originates in the PBX and extension numbers on that switch can be dialed. To get an outside line, an access code must be dialed. If this access code appears in this list, it is ignored and the toll restriction plan examines the digits following the PBX access code which has five entries numbered 1 through 5. There is a maximum of four digits for each entry.

PROCEDURE**LCD DISPLAY**

1. Press **[TRANSFER]** and dial **62**

PBX1:

2. Press **[VOLUME (-) or (+)]** to select the entry

PBX2:

3. Enter new PBX access code(e.g. 9) (maximum 4 digits)

PBX1:9

4. Press **[TRANSFER]** to save and exit

DEFAULT DATA

NONE

RELATED MMC

NONE



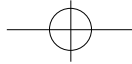

MMC 63

AUTHORIZATION TABLE

This MMC is used to list all allowable authorization codes. An authorization code must be four digits long. There are 50 codes allowed in this table. Duplications or number conflicts are not permitted. Each authorization code has an associated dialing class of service. When the code is entered, the dialing class of service is changed to that of the authorization code.

PROCEDURE

LCD DISPLAY

1. Press **[TRANSFER]** and dial **63**

AUTH.CODE

2. Enter two digits (01~50), or press **[VOLUME (-)]** or **[+]** to select the entry

AU01: COS:

3. Enter four digit code and dialing class (e.g. 1207 and 1)
There are five dialing class

AU01:0312 COS:1

- 1 : A CLASS
- 2 : B CLASS
- 3 : C CLASS
- 4 : D CLASS
- 5 : E CLASS

4. Press **[TRANSFER]** to save and exit

DEFAULT DATA

NONE

RELATED MMC

MMC 46 ASSIGN DISA LINE

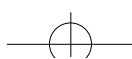

**MMC 64****OVERRIDE TABLE**

This MMC is used to enter up to five exceptions to toll restriction. These exceptions can be accessed by any class in both Day and Night modes, and are useful to allow access to emergency numbers. Caution should be used regarding the entries of this table because they will not be blocked for outgoing calls.

PROCEDURE**LCD DISPLAY**

1. Press **[TRANSFER]** and dial **64**

2. Press **[VOLUME (-) or (+)]** to select the urgent code number that you want

3. Enter the number to allow(e.g. 911)

4. Press **[TRANSFER]** to store and exit

DEFAULT DATA

NONE

RELATED MMC

NONE

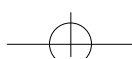

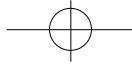

MMC 65

ASSIGN WILD CHARACTER

Provides flexibility to toll restriction when a specific numbering plan is desired. There are only three entry tables, but more than one digit can be assigned per table if necessary.

PROCEDURE

LCD DISPLAY

1. Press [TRANSFER] and dial 65	
2. Press [VOLUME (-) or (+)] to select the wild character (X,Y or Z)	
3. Enter 0 in the desired digit position. Twelve (12) digits must be entered. If there are less than twelve digits, data will not be changed	
4. Press [TRANSFER] to save and exit	

DEFAULT DATA

```

      1 2 3 4 5 6 7 8 9 0 * #
X : 1 1 1 1 1 1 1 1 1 1 1 1
Y : 1 1 1 1 1 1 1 1 1 1 1 1
Z : 1 1 1 1 1 1 1 1 1 1 1 1
    
```

RELATED MMC

- MMC 60 TOLL DENY TABLE/APPLY
- MMC 61 TOLL ALLOW TABLE/APPLY

Programming 64, 65



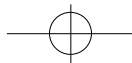

MMC 66 SYSTEM SPD-DIAL TOLL RESTRICTION

Enables you to define whether the system allows or denies long distance numbers in system Speed-Dialing to override toll restriction.

BYPASS TOLL Any station can use system speed dial numbers without restriction, regardless of class

FOLLOW TOLL The system checks all the system Speed-Dialings according to the station class and deny/allow table.

PROCEDURE

LCD DISPLAY

1. Press [TRANSFER] and dial 66	
2. Press [MUTE] or [MESSAGE] to select data OR Dial 1 for BYPASS TOLL or 2 for FOLLOW TOLL	
3. Press [TRANSFER] to save and exit	

DEFAULT DATA

BYPASS TOLL RESTRICTION

RELATED MMC



- MMC 30 STATION TOLL CLASS
- MMC 60 TOLL DENY TABLE/APPLY
- MMC 61 TOLL ALLOW TABLE/APPLY
- MMC 67 ASSIGN SYSTEM SPEED DIAL



**MMC 67****ASSIGN SYSTEM SPEED-DIAL**

This MMC is used to store up to eighty (80) system Speed-Dial numbers. The system Speed-Dial number is composed of 2 digits (20 to 99) and a maximum 30-digit telephone number can be stored at each Speed-Dial number. Eighty (80) system Speed-Dial numbers are available to every station and the toll restriction is determined by MMC 66. A Speed-Dial number consists of an access code and the telephone number to be dialed. The access code can be any trunk group, individual trunk, station group, or individual station. Dialing a valid trunk, trunk group, station or station group access number automatically inserts the separator character (:).

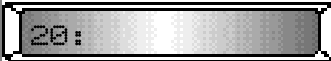
PROCEDURE**LCD DISPLAY**

1. Press [TRANSFER] and dial 67	
2. Using [VOLUME (-) or (+)] , select the entry OR Dial the entry number (20~99)	
3. Enter the speed dial number of up to 30 digits.	
4. Enter trunk access code (e.g. 9) followed by the number to be dialed (e.g. 1234567)	
5. Press [VOLUME (-) or (+)] to enter another speed dial number and return to step 3	
6. Press [TRANSFER] to save and exit	

DEFAULT DATA

NONE

RELATED MMC

NONE

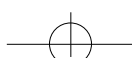

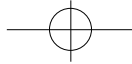
**MMC 70****DIAL NUMBERING PLAN**

This MMC provides the access codes and dialing plan needed for operation of features and programs. The system comes with a wide range of acceptable numbering plans set as default, and the option to customize the dialing plan. There is also a confirm message provided due to the chance of duplicating an access or feature code.

PROCEDURE**LCD DISPLAY**

1. Press **[TRANSFER]** and dial **70**

2. By pressing **[MUTE]** or **[MESSAGE]**, select the desired numbering plan group (STATION, STATION GRP, TRUNK, TRUNK GRP or FEATURE)

3. Search the desired numbering plan entry by pressing **[VOLUME (-) or (+)]**

4. Enter digits via the dial keypad (Max 3digits)

5. Press **[VOLUME (-) or (+)]** to enter change and continue to make changes

OR

Press **[MUTE]** or **[MESSAGE]** to enter change and continue to selecting numbering plan groups in step 2

If confirm message appears indicating duplication of access code, dial

0 for no change

1 for change

6. Press **[TRANSFER]** to save and exit

DEFAULT DATA

ACC	: 47	: ACCOUNT CODE
ALM	: 58	: ALARM
AMD	: 68	: ANSWER MODE
ATH	: 65	: AUTHORIZATION CODE
BRG	: 40	: BARGE-IN
CBK	: 44	: CALL BACK
CMP	: 45	: CAMP-ON
CNF	: 46	: CONFERENCE
COS	: 59	: CLASS OF SERVICE
CPS	: 54	: CHANGE PASSCODE
DND	: 64	: DO NOT DISTURB
DOR	: 13	: DOOR



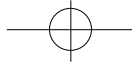

MMC 70

DPC	: 10	: DIRECT PICKUP
EXC	: 12	: EXECUTIVE / SECRETARY
FAT	: 14	: FORCED AUTO ANSWER
FLS	: 49	: FLASH
FWA	: 61	: CALL FORWARD ALL
FWB	: 62	: CALL FORWARD BUSY
FWC	: 60	: CALL FORWARD CANCEL
FWN	: 63	: CALL FORWARD NO ANSWER
GPC	: 66	: GROUP PICK UP
GPS	: ★	: SELF GROUP PICK UP
HED	: 69	: HEADSET
HLD	: 11	: HOLD
IOG	: 53	: IN / OUT GROUP
LNR	: 19	: LAST NUMBER REDIAL
MPG	: 56	: MEET ME PAGE
MSA	: 43	: MESSAGE ANSWER
MSC	: 42	: MESSAGE CLEAR
MSL	: 41	: MESSAGE LEFT
OPR	: 0	: OPERATOR
PAG	: 55	: PAGE
REC	: 18	:DISA VOICE RECORDING
SDI	: 15	: SPEED DIAL INSERTION
SGR	: 500-519	: STATION GROUP
SNR	: 17	: SAVED NUMBER REDIAL
SPD	: 16	: SPEED
STN	: 2XX	: STATION NUMBER
TRK	: 7XX	: TRUNK NUMBER
TGR	: 9, 80~89	: TRUNK GROUP
UPC	: 67	: UNIVERSAL NIGHT ANSWER
VAC	: 48	: VACANT MESSAGE

RELATED MMC

ALL PROGRAMS AND FEATURES

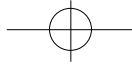



MMC 71

SYSTEM KEY PROGRAMMING

This MMC allows for the customizing of programmable keys system-wide.

PROCEDURE

LCD DISPLAY

1. Press **[TRANSFER]** and dial **71**

TYPE: NX24

2. Using **[VOLUME (-)]** or **[+]**, select the type of keyset
*There are 7 keyset types: NX 24, NX 12, NX 6,
 SKP 816, AS 30, AS 12S, NX AOM.*

TYPE: NX12

3. Press the desired key
 OR
 Press **[REDIAL]** or **[FLASH]** to select desired key. (e.g. 13)

13: NONE

4. Enter the key programming via keypad.

Trunk number, Trunk Group number, Station number, Station Group number, or feature number can be programmed into the keys.

*If you want to program a feature key, enter ***** before the feature key ID (e.g. NIT : *26). Press **[MUTE]** or **[MESSAGE]** to scroll the feature Programmable key assignments are listed below. To change another key, return to step 3.*

13: *26

5. Press **[TRANSFER]** to save and exit.

DEFAULT DATA

NX-24E/NX-24B					
19: 207	20: 208	21: 209	22: 210	23: 211	24: 212
13: 201	14: 202	15: 203	16: 204	17: 205	18: 206
07: 707	08: 708	09: NONE	10: NONE	11: NONE	12: NONE
01: 701	02: 702	03: 703	04: 704	05: 705	06: 706

NX-12E/NX-12B					
07: 201	08: 202	09: 203	10: 204	11: 205	12: 206
01: 701	02: 702	03: 703	04: 704	05: 705	06: 706

NX-6B					
01: 701	02: 702	03: 703	04: 704	05: 705	06: 706

AS-30					
01: 701	02: 702	03: 703	04: 704	05: 705	06: 706
07: 707	08: 708	09: 709	10: 710	11: 711	12: 712
13: 201	14: 202	15: 203	16: 204	17: 205	18: 206
19: 207	20: 208	21: 209	22: 210	23: 211	24: 212
25: 213	26: 214	27: 215	28: 216	29: 217	30: 218

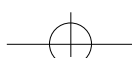

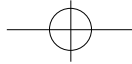
NX-SERIES HYBRID KEY SYSTEM

PROGRAMMING SECTION

MMC 71

SKP-816						
09: 201	17: 209		01: 701	02: 702	03: 703	04: 704
10: 202	18: 210		05: 705	06: 706	07: 707	08: 708
11: 203	19: 211					
12: 204	20: 212					
13: 205	21: 213					
14: 206	22: 214					
15: 207	23: 215					
16: 208	24: 216					

NX-AOM	
01: NONE	13: NONE
02: NONE	14: NONE
03: NONE	15: NONE
04: NONE	16: NONE
05: NONE	17: NONE
06: NONE	18: NONE
07: NONE	19: NONE
08: NONE	20: NONE
09: NONE	21: NONE
10: NONE	22: NONE
11: NONE	23: NONE
12: NONE	24: NONE

Programmable Key Assignment

★00 : ACC	Account code	★18 : GPC	Group Pickup
★01 : ALM	Set Alarm	★19 : HED	Headset mode
★02 : AMD	Answer Mode	★20 : IOG	Group In/Out
★03 : ARD	Auto Redial	★21 : LNR	Last Number Redial
★04 : BRG	Barge-In	★22 : LSN	Group Listening
★05 : CBK	Callback	★23 : MPG	Meet Me Page
★06 : CMP	Camp-on	★24 : MSG	Message
★07 : CNF	Conference	★25 : MUT	Mute
★08 : DND	Do Not Disturb	★26 : NIT	Night mode
★09 : DOR	Door	★27 : OPR	Operator group
★10 : DPC	Direct Pickup	★28 : PAG	Page
★11 : EXC	Boss/Secretary	★29 : PSE	Pause Dialing
★12 : FAT	Forced Auto Answer	★30 : SNR	Saved Number Redial
★13 : FLS	Flash	★31 : SPD	Speed Dialing
★14 : FWA	Call Forward All	★32 : TMR	Timer
★15 : FWB	Call Forward Busy	★33 : TRN	Transfer
★16 : FWE	External Call Forward	★34 : UPC	UNA Pickup
★17 : FWN	Call Forward No answer	★35 : VAC	Vacant Message

NOTE : The SPD, VAC, PAG, DOR, EXC, DPC, GPC keys can be assigned with extenders. Refer to MMC 16 KEY EXTENDER.

RELATED MMC

MMC 16 KEY EXTENDER
MMC 72 STATION KEY PROGRAMMING









MMC 72

STATION KEY PROGRAMMING

This program allows customizing programmable keys on specific electronic keysets on the system. The program also provides a tool for duplicating data to other keysets to have the same key format structure. Copy source and target sets must be same type keyset.

PROCEDURE

LCD DISPLAY

1. Press [TRANSFER] and dial 72	
2. If you want to copy from another station key assignment, enter the station number OR Press [VOLUME (-) or (+)] to select the station	 
3. Press the desired key OR Press [REDIAL] or [FLASH] to select desired key	
4. Press dial pad key number to make selection. If you want to change another key, return to step 3	
5. Press [TRANSFER] to save and exit	

DEFAULT DATA

Same as MMC 71

RELATED MMC

MMC 16 KEY EXTENDER

MMC 71 SYSTEM KEY PROGRAMMING

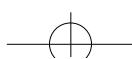

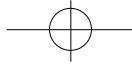
**MMC 73****KEY TEST**

This program allows you to check whether each key works properly.

PROCEDURE**LCD DISPLAY**

1. Press **[TRANSFER]** and dial **73**
All LEDs light and station rings. Display sets show the full matrix pattern for 16 characters.
All tri-color LEDs light amber
2. Press each function button and dial pad key to test its operation. Display sets will show the corresponding key name. Buttons with LEDs will turn OFF and stay OFF when pressed
3. Lift the handset to end testing

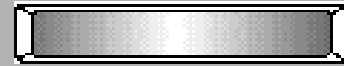
**DEFAULT DATA**

NONE

RELATED MMC

NONE

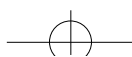

**MMC 80****SYSTEM I/O PARAMETERS**

This MMC provides a means of setting parameters for the serial I/O ports to work with SMDR and Remote MMC. Programming is accomplished easily with the tables below to customize either I/O port.

PARAMETER	OPTIONS
TYPE OF SERVICE	SMDR, REMOTE, TRAFFIC
REMOTE STN	REMOTE only
BAUD RATE	300, 600, 1200, 2400, 4800, 9600 BPS
CHARACTER LENGTH	7 BIT, 8 BIT
PARITY	NONE, EVEN, ODD
STOP BIT	1

PROCEDURE**LCD DISPLAY**

1. Press **[TRANSFER]** and dial **80**
Display Shows

2. Press **[VOLUME (-)]** or **[+]** to select the serial port (COM1, COM2) COM1 and COM2 may be found on SMDR/R-MMC card. COM1 is SMDR and COM2 is R-MMC. COM1 is used for SMDR or TRAFFIC port and COM 2 is used for Remote Programming.

3. Press **[REDIAL]** or **[FLASH]** to select the parameters

4. Press **[MUTE]** or **[MESSAGE]** to select data

5. Press **[TRANSFER]** to save and exit

DEFAULT DATA

COM1	: 9600 8 NONE
COM2	: 9600 8 NONE
COM1	: XON OFF : ON
COM2	: XON OFF : ON
SMDR	: COM1
TRAFFIC	: COM1
REMOTE	: COM2 STN : NONE

NOTE: "XON OFF" means whether the system checks the CTS pin of the serial port or not 'REMOTE STN' means the port displaying the Remote MMC procedure.

RELATED MMC

NONE





MMC 81

SMDR OPTIONS

This MMC allows the system administrator to select information to be printed on the SMDR report.

OPTIONS	DESCRIPTIONS
PAGE HEADER	This option determines whether a page header will print at the top of each page. Normally turned off if SMDR is sent to a call accounting machine.
LINE PER PAGE	This option selects the length of each page to determine where to print the SMDR header. The number of lines may be in the range 10 through 99.
INCOMING CALL	This option determines whether or not incoming calls will print on SMDR.
AUTHORIZE CODE	This option determines whether or not the table of authorization codes will print on SMDR.
LESS START TIME	This option determines whether or not valid calls will include the minimum call time in total call duration.
ALARM	This option determines whether or not stations receiving an alarm reminder call will print on SMDR.
COMPANY NAME	This option allows the system administrator to enter a 16 character name which will appear in the SMDR header.

PROCEDURE

LCD DISPLAY

1. Press [TRANSFER] and dial 81	
2. Press [VOLUME (-) or (+)] to select the parameter	
3. Press [MUTE] or [MESSAGE] to select data OR Using KEYPAD, dial 0 for NO 1 for YES In case of LINE PER PAGE, enter the line number (17~99)	
4. In case of COMPANY NAME, refer to MMC 14 (STATION NAME)	
5. Press [TRANSFER] to save and exit	

DEFAULT DATA

PAGE HEADER	: YES	LINE PER PAGE	: 66
INCOMING CALL	: NO	AUTHORIZE CODE	: YES
LESS START TIME	: NO	ALARM	: NO
COMPANY NAME	: NONE		

RELATED MMC

MMC 80 IO PARAMETER

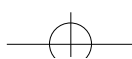

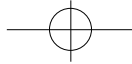
**MMC 83****CALL TRAFFIC REPORT**

This MMC is used to print a traffic report and select options. Four types of printing are available, each with has two options. These are listed below:

NO.	TYPE	DESCRIPTION
0	NO	No print
1	NOW	Printed on demand
2	DAILY	Printed at the end of day automatically (PM 12:00)
3	WEEKLY	Printed at the end of week automatically (PM 12:00 on Saturday)

NO.	OPTIONS	DESCRIPTION
0	CLEAR	A report is printed and all totals are reset to 0
1	SAVE	A report is printed and all totals are saved

PROCEDURE**LCD DISPLAY**

1. Press **[TRANSFER]** and dial **83**

PRINT : NO

2. Press **[MUTE]** or **[MESSAGE]** to select type
OR
Using **KEYPAD**, dial
0 for **NO**
1 for **NOW**
2 for **DAILY**
or **3** for **WEEKLY**

PRINT : WEEKLY

3. Press **[VOLUME]** and dial 0 for **CLEAR**, or 1 for **SAVE**
You have to select one of the types in step 2 and also one selection in step 3 to print the traffic report

DATA: SAVE

4. Press **[TRANSFER]** to save and exit

DEFAULT DATA

PRINT : NO
DATA : SAVE

RELATED MMC

MMC 80 IO PARAMETER



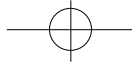

MMC 90

CUSTOMER USE MMC

Allows the station user access to certain MMCs. For example, it is advised that the user have access to MMC11 Call Forward, but not MMC60 Toll Deny.

PROCEDURE

LCD DISPLAY

1. Press [TRANSFER] and dial 90 .	
2. Press [VOLUME (-) or (+)] to select the MMC you want. OR Using KEYPAD , enter the desired MMC number.	
3. Press [MUTE] or [MESSAGE] to make selection. NO : Customer cannot access the MMC. YES : Customer can access the MMC.	
4. Press [TRANSFER] to save and exit.	

DEFAULT DATA

00:STN LOCK	:YES	41:TRK DIAL	:NO
01:STN CODE	:YES	42:TRK MISC	:NO
10:ANS MODE	:YES	43:TRK RING	:NO
11:CALL FWD	:YES	44:TRK NAME	:NO
12:STN MISC	:YES	45:TRK GRP	:NO
13:RING FREQ	:YES	46:DISA LINE	:NO
14:STN NAME	:YES	50:SYS TIME	:NO
15:DATE FORM	:YES	51:TONE CADE	:NO
16:KEY EXTEN	:YES	52:SYS CNTR	:NO
17:STN SPD	:YES	53:TRK TIME	:NO
20:PGM MODE	:NO	54:MAKE RATE	:NO
21:PGM CODE	:YES	55:DATE TIME	:YES
22:CUS MISC	:YES	56:NITE TIME	:YES
23:PAGE ZONE	:NO	57:CALL COST	:NO
24:BARGE IN	:NO	60:TOLL DENY	:NO
25:HOT WARM	:YES	61:TOLL ALLOW	:NO
26:ALM CLK	:YES	62:PBX CODE	:NO
27:VAC MSG	:YES	63:AUTH CODE	:NO
28:CALL DISC	:NO	64:URGENT CD	:NO
30:STN COS	:NO	65:WILD CHAR	:NO
31:TRK USE	:NO	66:SPD TOLL	:NO
32:INTERCOM	:NO	67:SYS SPD	:YES
33:DOOR RING	:NO	70:NUM PLAN	:NO
34:PICK GRP	:NO	71:SYS KEY	:NO
35:STN GRP	:NO	72:STN KEY	:NO
36:BOSS SECR	:YES	73:KEY TEST	:NO
37:SET AOM	:NO	80:IO PARA	:NO
38:SLT TYPE	:NO	81:SMDR OPT	:NO
39:DATA LINE	:NO	83:TRFC RPT	:YES
40:PBX LINE	:NO		

RELATED MMC

NONE

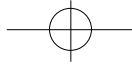

**NX-SERIES** HYBRID KEY SYSTEM

PROGRAMMING SECTION

MMC 91**SYSTEM VERSION**

This MMC provides display of the current software version of the KSU and the KEYSET, and the date the product was made. This is a READ ONLY MMC.

PROCEDURE**LCD DISPLAY**

1. Press **[TRANSFER]** and dial **91**

2. Press **[VOLUME (-) or (+)]** to select a display

3. Press **[TRANSFER]** to and exit.

DEFAULT DATA**RELATED MMC**

NONE

MMC 92**PORT STATUS**

This MMC displays the sixteen(16) port attributes:

IDLE, BUSY, CALLBACK, DOOR RING, TRK RING, STN RING, GRP RING, RCL RING, PROGRAM, ON T HOLD, ON S HOLD, ON E HOLD, IS PAGED, IS SEIZED, WRAP UP, OFF HOOK.

PROCEDURE**LCD DISPLAY**

1. Press **[TRANSFER]** and dial **92**

2. Press **[VOLUME (-) or (+)]** and to see the port status.

3. To clear the port status, press **[HOLD]**

4. Press **[TRANSFER]** to save and exit.

DEFAULT DATA

IDLE

RELATED MMC

NONE

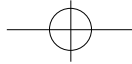

**MMC 93****LANGUAGE SELECTION**

Used to select one of three (3) languages to display in keyset LCDs.

Choose an entry number from the table below:

ENTRY NUMBER	LANGUAGE
1	ENGLISH
2	SPANISH
3	PORTUGUESE

NOTE : English is displayed while in MMC mode.

PROCEDURE**LCD DISPLAY**

1. Press **[TRANSFER]** and dial **93**
Display shows...



2. Press **[MUTE]** or **[MESSAGE]** to select a language.
OR
Using KEYPAD, dial
1 for ENGLISH
2 for SPANISH
or **3 for PORTUGUESE**



3. Press **[TRANSFER]** to save and exit.

DEFAULT DATA

ENGLISH

RELATED MMC

NONE

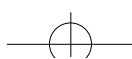

**MMC 94****HALT PROCESS**

Use only in the event that all data processing must be stopped.

The four-digit Technician Passcode is required to access this MMC. This MMC will not interfere with any call in progress, but attempting a new call will result in a busy tone.

PROCEDURE**LCD DISPLAY**

1. Press **[TRANSFER]** and dial **94**

PASSCODE :

2. Enter Technician passcode.

PASSCODE :****

3. Press **[MUTE]** or **[MESSAGE]** to select data.
OR
Using KEYPAD, dial
0 for PROCESSING
1 for HALT

PROCESSING

4. Press **[TRANSFER]** to save and exit.

DEFAULT DATA

PROCESSING

RELATED MMC

NONE

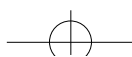

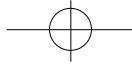

MMC 95

SYSTEM RESTART

Provides two methods of restarting the system.

OPTIONS	DESCRIPTION
RESET SYSTEM	Restart the system only.
CLEAR MEMORY	Restart the system and clear all memory and set all functions to their default values.

Extreme care should be taken when using this MMC. If the system is restarted, all voice/data connections are dropped. Clearing memory will delete all customer data and system returns to default status.

PROCEDURE

LCD DISPLAY

1. Press [TRANSFER] and dial 95	PASSCODE :
2. Enter the technician passcode.	RESET SYSTEM?
3. Press [VOLUME (-) or (+)] to select the option. OR Using KEYPAD, dial 0 for NO or 1 for YES.	CLEAR MEMORY?
<i>If case of CLEAR MEMORY, dial 0 for NO or 1 for YES to remind you of your choice.</i>	ARE YOU SURE?

DEFAULT DATA

NONE

RELATED MMC

NONE

Programming 94, 95

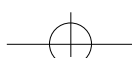



NX-SERIES HYBRID KEY SYSTEM

PROGRAMMING SECTION



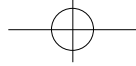

APPENDIX SECTION

- A. REMOTE PROGRAMMING**
- B. DATABASE DOWNLOAD**
- C. DISA VOICE ANNOUNCEMENT**





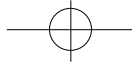

APPENDIX A REMOTE PROGRAMMING

Remote programming capability has been incorporated in the NX-SERIES via the R-MMC serial port on the SMDR/R-MMC board option mounted on the base unit. This port is configured as a programming port only. The remote programming capability of the NX-SERIES can be used to add, delete, or modify a customer database. While remote programming gives added flexibility to the NX-SERIES, it is not possible to UP/DOWN load from or to a disk or tape. All NX-SERIES MMCs may be accessed via remote programming.

1. SITE REQUIREMENTS

1.1 CUSTOMER SITE REQUIREMENTS

Before using remote programming, the following requirements must be met at the customer site:

Install the optional **NX-SMDR/R-MMC** board in the base unit.

MMC 80 Change Baud Rate: This MMC will set the baud rate of communication R-MMC port to match the customer site's modem. Baud rate selections are 300, 600, 1200, 2400, 4800, and 9600. 8 Data bits, No parity, 1 stop bit is default.

MMC 80 Assign Remote Port: When remote programming is used, it must reference an installed **NX24E** keyset at the customer site. This keyset will be disabled for the duration of the remote programming session. When remote programming is not in use, this assigned keyset will function normally. The keyset port selection should be made considering minimal inconvenience to site personnel during programming sessions.

NOTE: There are no physical connections between the keyset and modem or keyset and communication port. The assigned keyset is used as a software reference point only.

A customer-provided modem and cable connected to R-MMC comm port, as shown below:

A voice grade dial-up line on which the modem may be called.

1.2 REMOTE SITE REQUIREMENTS

Personal computer (PC) with communication software that can emulate VT-102 terminal.

NOTE: Since communication software can vary, no assurance can be made that every communications software package will work properly.

Internal or external modem able to match baud rate speed with the modem at the customer site

Voice grade dial line to call customer modem.

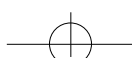

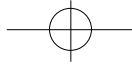

1.3 BEGIN PROGRAMMING

Dial the customer modem number and establish a communication link with the customer site.

Once communication is established, press the TAB key on the PC keyboard to receive the NX-SERIES system header display (below).

If you receive a "SORRY!DESTINATION PORT IS BUSY" display, the keyset assigned in **MMC 80 REMOTE STATION** is currently busy and no remote programming can be done at this time.

When the NX-SERIES system header is displayed, enter MMC 20 and the necessary passcode to open programming and begin the remote programming session.

```
WELCOME TO NX SERIES REMOTE PROGRAM
-----

CUSTOMER   :
DATE       : Sat, 01, Jan
TIME       : 00:02
-----

TRANSFER   : TAB
SPEAKER    : RETURN
UP/DOWN    : UP/DOWN
REDIAL/FLASH: LEFT/RIGHT
HOLD       : BACKSPACE

PROGRAM CODE:
```

1.4 PROGRAMMING PROTOCOL

The NX-SERIES will only recognize those keystrokes which have been assigned as NX-keyset equivalent. These keystrokes are fixed and are not programmable. Use the PC equivalent in place of the **NX 24E** keys as called for in **MMC** programming procedures. These keystrokes are described below. Dial pad number may be entered using the standard number keys of the PC keyboard, or the number pad on the right side of the PC keyboard (when equipped).

CAUTION : DO NOT USE **MMC 73** or **MMC 95**, option 2, while in remote programming. Defaulting the system with clear data necessary for remote programming. Someone at the customer site will then be needed to assign the necessary data for remote programming to work.

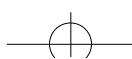

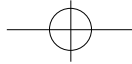

2. ON-SITE PROGRAMMING VIA PC TERMINAL

On-site programming via a PC terminal has been incorporated in the **NX-SERIES** via serial communication port **R-MMC** of the **SMDR/R-MMC** board mounted on the Base board. This port is configured as a programming port only. The on-site programming capability of the **NX-SERIES** can be used to add, delete, or modify the customer database. While on-site programming gives added flexibility to the **NX-SERIES**, it is not possible to UP/DOWN load from or to a disk or tape.

ALL NX-SERIES MMCs may be accessed via on-site programming.

2.1 ON-SITE REQUIREMENTS

Before on-site programming can be used, the following requirements must be fulfilled:

An installed optional **SMDR/R-MMC** board in the base unit.

A customer-provided PC terminal with communication software that can emulate a VT-103 type terminal.

NOTE: Since communication software can vary no assurance can be made that every communications software package available will work.

MMC 80 Change Baud Rate: This MMC sets the baud rate, data bits, parity bit, and stop bit parameters of the **R-MMC** port on the **SMDR/R-MMC** board to match the customer's PC terminal. Baud rate speed selections are 300, 600, 1200, 2400, 4800 and 9600. 8 data bits, 7 data bits, No parity, Even parity, Odd parity, 1 stop bit, and 2 stop bits are selectable.

MMC 80 Assign Remote Port: When on-site programming is used, it must reference an installed **NX 24** keyset at the customer site. This assigned keyset will be disabled for the duration of the on-site programming session. When on-site programming is not in use, this keyset will function normally. A keyset port selection should be made that will offer minimal inconvenience to personnel site.

NOTE: There are no physical connections between the assigned keyset and the communication port. The assigned keyset is used as a software reference point only. If the assigned keyset is a display keyset, it will echo the programming keystrokes from the PC terminal.

A customer-provided cable must be connected between the PC terminal and **COM R-MMC** port.

2.2 BEGIN PROGRAMMING

Once communications has been established, press TAB on the PC keyboard to receive the **NX-SERIES** header display (below). A "SORRY DESTINATION PORT IS BUSY" display indicates that the keyset assigned in **MMC 80** is currently busy, and no on-site programming can be done at this time. When the **NX-SERIES** header is displayed, enter **MMC 20** and the necessary passcode to

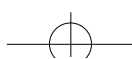



open programming and begin the on-site programming session.

NOTE: The header will display CUSTOMER and the name assigned in **MMC 81**.

2.3 PROGRAMMING PROTOCOL

The **NX-SERIES** will only recognize keystrokes on the PC keyboard that have been assigned as **NX 24** keyset equivalent. These keystrokes are fixed and are not programmable. Use the PC equivalent in place of the **NX 24** keys as called for in **MMC** programming procedures. These keystrokes are described below. Dial pad numbers may be entered using the number keys of the PC keyboard, or the number pad on the right side of the PC keyboard (when equipped).

WELCOME TO NX SERIES REMOTE PROGRAM

CUSTOMER :
DATE : Sat, 01, Jan
TIME : 00:02

TRANSFER : TAB
SPEAKER : RETURN
UP/DOWN : UP/DOWN
REDIAL/FLASH: LEFT/RIGHT
HOLD : BACKSPACE

PROGRAM CODE:



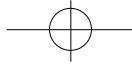

APPENDIX B DATABASE DOWNLOAD

1. Introduction To Database Download Programming

A database download programming capability has been incorporated into the **NX-SERIES** via the communication (serial) **SMDR** port of the optional **SMDR/R-MMC** card mounted in the base unit.

This is a software utility designed to allow a certified **NX-SERIES** technician the ability to perform a database download on-site.

1.1 Customer Site Requirements

Certain conditions must be satisfied before installing the software package on a personal computer:

- 1) Install the optional **NX-SMDR/R-MMC** card in the base unit.
- 2) Use a 286 or higher IBM-PC or 100% IBM-compatible computer with the following
 - MS-DOS** version 5.0 or higher
 - MS-WINDOWS** version 3.1 or higher
 - 3 ¼" or 5 ½" high-density floppy drive
 - VGA** monitor.
3. Rs-232C cable

2. Installing Database Downloading

2.1 Getting Started

- 1) Create a directory to store the **DATABASE DOWNLOAD** program.
- 2) Copy the file to the new directory. The file is compressed and will have a name similar to **NX71229.exe** where **71229** is the date the file was generated.
- 3) Type "**NX71229**" to uncompress the file or Double-click file name on the file name in the Windows file manager.
- 4) Double-click on the icon that was created by the install program in the Windows file manager - "**NX_DOWN.EXE**".

3. Setup of Database Downloading Program

3.1 Starting NX Download Program

- 1) Connect the cable required (**RS-232C**)
- 2) Turn on the **PC**.

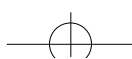



- 3) Enter the **DATABASE DOWNLOAD** directory.
- 4) Double-click on the icon that was created by the install program in the Windows - "**NX_DOWN**"
- 5) You will see Windows shown below.

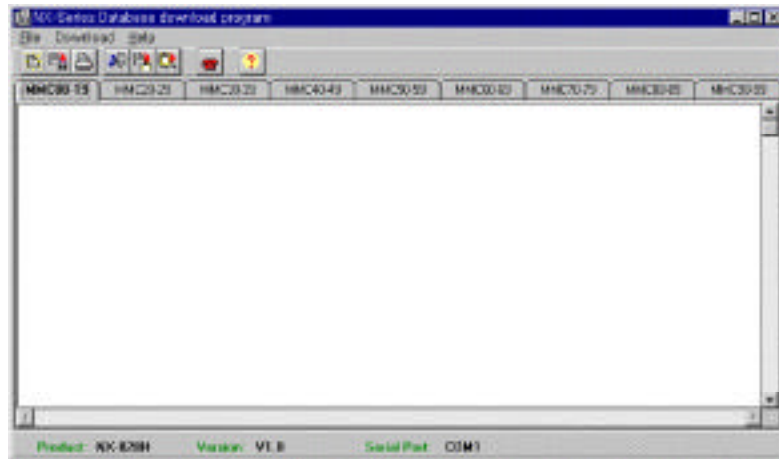

Figure 1.1 Main Window

3. 2 Setup Of Database Downloading Program

Setup is one of the most important parts of the **DOWNLOAD PROGRAM**. Many problems can result simply from an incorrect connection. The **DATABASE DOWNLOADING** program communicates with the **NX-SERIES** via the COM port in your computer and a port on the **NX-SMDR/R-MMC** card. Select the required option and a check mark appears in the check box.

- 1) Choose Download / Version***
- 2) Select the item in the Product check box
- 3) Select the item in the Version check box.
- 4) Select the item in the Country check box(optional)
- 5) Select OK button.



Figure 1.2 Version & Product Dialog Box

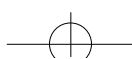



- 6) Choose Download / Serial Port***
- 7) Check **COM** port in the Select serial port check box
- 8) Select OK button.

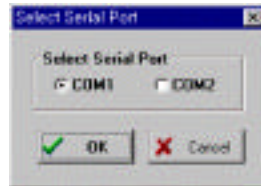

Figure 1.3 Port dialog box

4. Using database downloading program

4.1 Downloading

- 1) Choose **DOWNLOAD** / Download to File***.
- 2) Input file name that will contain the **MMC** data.
- 3) Select Download button.
- 4) "**DOWNLOADING...** Press ESC key to cancel" will be displayed on the screen. It will take about 15 minutes to finish database downloading.

NOTE:

If the download fails, recheck the setup as described above and repeat the process.
If the Program stops during downloading, please wait for 5-10 sec, until the program restarts.

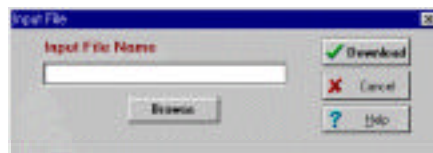
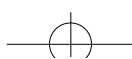

Figure 1.4 Input File name dialog box

4.2 Open file

You can now open the downloaded database file.

- 1) **Click MMC** page tab that you want to see.
or
- 2) You can use another editor e.g.) the built-in DOS editor, Notebook, or another Windows editor.



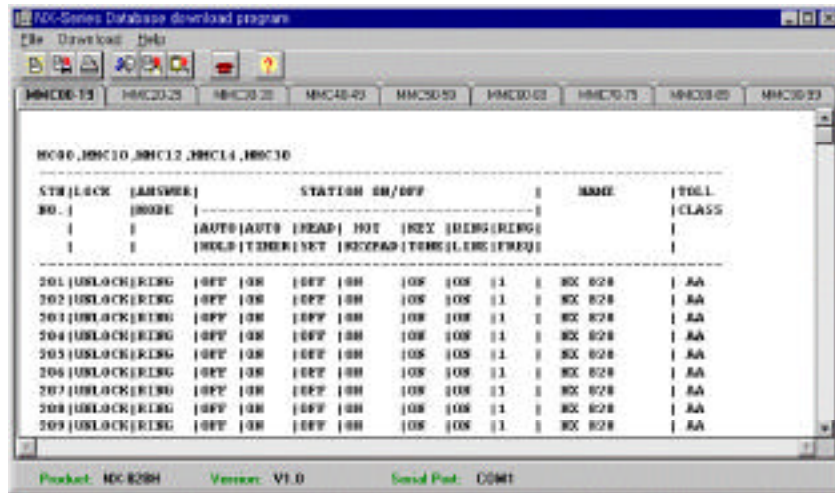
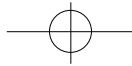

Figure 1.6 MMC page tab

4.3 Save file

This option saves the downloaded file with another name with the save file option.

4.4 Print file

This option prints the database file that you downloaded

4.5 Help

This option shows the program version

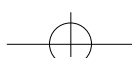

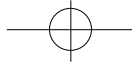

APPENDIX C DISA VOICE ANOUNCEMENT

1. DISA AUTOMATIC ANSWER

The system answers automatically an incoming **DISA** (Direct Inward System Access) call and sends the message: **"This is XXX company. Extension number, please"**. This facilitates handling your DISA calls and tells the calling party the status of the called extension via recorded voice message phrase 2 or 3.

The message is approximately 5 seconds long. (15 secs for guide information.)

You can record any message you want.

2. PHRASES

PHRASE	CONTENTS	TIME
1	Guide information	15 sec
2	Busy state	5 sec
3	Invalid input	5 sec
4	Operator transfer	5 sec

NOTE

If called extension is busy, a voice message (phrase 2 and 4) is sent to the calling party.

If the digits dialed by calling party are an invalid number, a voice message (phrase 3) is sent to the calling party.

If you use this function, set '**VOICE MESSAGE**' to '**ON**' in **MMC 42**.

3. RECORD & VERIFY MESSAGE

3.1 Recording

Dial '18' and the customer passcode Display: 'RECORD:PLAY ?'.

Press '0', and record phrase 1

After recording phrase 1, phrase 1 will play back automatically for checking.

Display: 'RECORDING' in LCD for phrase 2

Record phrase 2, and phrase 2 will play back automatically.

Follow the same procedure for phrases 3 and 4.

3.2 Recording

Dial '18' and the customer passcode Display: 'RECORD:PLAY ?'.

Select phrase number (1~4) you want to record, and display 'RECORDING' in LCD.

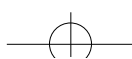

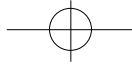

Start to record through handset or speaker phone.

After recording, you can hear automatically the recorded message.

NOTE

In case of first Power on, record phrase 1 to phrase 4 in sequence.

3.3 Monitoring

Dial '18' and the customer passcode Display: 'RECORD:PLAY ?'.

Select phrase number (5~8) to play back; Display: 'PLAYING'.

You will hear the selected message.

NOTE

In order to change a recorded message, record a new message following procedure (1), so the message will be updated.

If you perform the monitoring procedure (2) when no message is recorded, you may hear an error tone.

You cannot record a message while a message is being played back.

If you stop during recording, you can neither record a new message, nor monitor a recorded message, until the predetermined record time elapses.

The above description specifies '18' to be dialed for recording. This number may have been changed by data setting. Confirm the number with the installer.

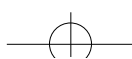

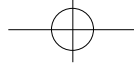

BACK-UP DATA SHEETS

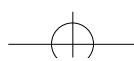



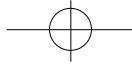

NX- _____ SYSTEM

DATABASE FORMS

CUSTOMER NAME : _____

ADDRESS : _____

TELEPHONE NUMBER : _____

DATABASE CONTAINS _____ SHEETS

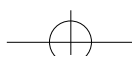



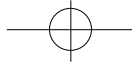

MMC 24 BARGE-IN	
OPTION :	
STATION NO.	BARGE-IN CLASS

MMC 25 HOT / WARM LINE		
STATION NO.	DESTINATION	WARM LINE DELAY TIME

MMC 26 ALARM REMINDER			
STATION NO.	ALARM NO.	ALARM TIME	DAY/DALY

MMC 27 VACANT MESSAGE	
MESSAGE NO.	MESSAGE

MMC 31 TRUNK USE			
STATION NO.	TRUNK NO.	DIAL	ANSWER

COPY AS NEEDED

SHEET ____ OF ____



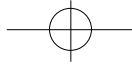

MMC 32 INTERCOM USE		
STATION NO.	DESTINATION STATION	USE

MMC 33 ASSIGN DOOR RING		
DOOR NO.	DAY	NIGHT

MMC 34 PICKUP GROUP		
GROUP NO.	MEMBER ID	STATION NO.

PICKUP GROUP NO. :				

MAXIMUM NUMBER OF PICKUP GROUPS IS 10.

MMC 35 STATION GROUP				
STATION GROUP NO. :				
RING	OVERFLOW TIME	TRSF. TIME	OVERFLOW PORT	TYPE
NUMBER				

MAXIMUM NUMBER OF STATION GROUPS IS 20.

MMC 36 BOSS / SECRETARY		
SECRETARY	BOSS 1	BOSS 2

COPY AS NEEDED

SHEET ____ OF ____



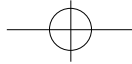

MMC 37 ADD-ON MODULE					
AOM	MASTER	AOM	MASTER	AOM	MASTER

MMC 38 SLT DIALING TYPE			
STATION NO.	TYPE	STATION NO.	TYPE

MMC 39 DATA LINE			
STATION NO.	VOICE / DATA	STATION NO.	VOICE / DATA

MMC 40 C.O. PBX LINE			
TRUNK NO.	CO/PBX	TRUNK NO.	CO/PBX

TRUNK LINE DATA									
TRUNK NO.	DIAL TYPE (41)	TRUNK ON / OFF (42)					ASSIGN RING (43)		NAME (44)
		1A2EMUL	FORWARD	PAGE RING	TOLL FREE	VOICE MSG	DAY	NIGHT	

COPY AS NEEDED

SHEET ____ OF ____





MMC 45 TRUNK GROUP							
MODE :							
GROUP NO. :							
MEMBER :							

MAXIMUM NUMBER OF TRUNK GROUPS IS 11.

MMC 46 ASSIGN DISA LINE		
TRUNK NO.	DISA OPTION	VOICE MSG (42)

MMC 50 SYSTEM TIMERS			
TIMER	RANGE	DEFAULT	NEW
ALM R INT	1~250 sec	025 sec	
ALM R DUR	1~250 sec	010 sec	
ARDL INT	1~250 sec	045 sec	
ARDL REAL	1~250 sec	045 sec	
CBACK NOA	1~250 sec	030 sec	
CO CO DIS	1~250 min	010 min	
DISA F DG	1~250 sec	025 sec	
DISA I DG	1~250 sec	025 sec	
DISA RING	1~250 sec	030 sec	
DOOR RELS	100~2500 ms	1500 ms	
DOR R OFF	1~250 sec	030 sec	
FIRST DGT	1~250 sec	025 sec	
HOOK OFF	100~2500 ms	0200 ms	
INTER DGT	1~250 sec	025 sec	
MMC OUT	10~250 sec	030 sec	
OFF R INT	1~250 sec	015 sec	
PAGE MAX	1~250 sec	020 sec	
RCAL DISC	1~250 min	002 min	
RCAL RING	0~250 sec	015 sec	
RCAL WAIT	0~250 sec	015 sec	
RCAL HOLD	0~250 sec	045 sec	
RCAL TRSF	0~250 sec	045 sec	
SLT F MIN	10~2500 ms	0350 ms	
SLT F MAX	10~2500 ms	0800 ms	

COPY AS NEEDED

SHEET ____ OF ____



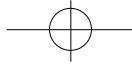

SMDR PULAS	1~250 sec	030 sec	
SMDR DRMF	0~250 sec	015 sec	
TRK DISC	1~250 min	030 min	

MMC 51 TONE / RING CADENCE

TONE/RING	ON	OFF	ON	OFF

MMC 52 SYSTEM WIDE COUNTER

OPTION	COUNTER

MMC 53 TRUNK WIDE TIMER

TIMER	RANGE	DEFAULT	NEW
CLEARING	1~25 sec	00 sec	
CO SUPV	100~2500 ms	0000 ms	
F DGT DLY	100~2500 ms	1000 ms	
FLASH PBX	100~2500 ms	0600 ms	
MFS ON TM	100~2500 ms	0100 ms	
MF OFF TM	100~2500 ms	0100 ms	
NEW CALL	100~9900 ms	2000 ms	
NO RING	1~250 sec	05 sec	
PAUSE TM	1~250 sec	003 sec	
RNG DETCT	100~2500 ms	0200 ms	

MMC 54 MAKE / BREAK RATIO

MAKE :		BREAK :	
--------	--	---------	--

MMC 56 ASSIGN AUTO NIGHT TIME

TABLE TYPE :		
SUB-TABLE NO.	DAY	NIGHT

COPY AS NEEDED

SHEET ____ OF ____

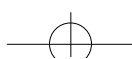

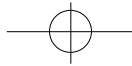

MMC 57 CALL COST	
UNIT COST :	

MMC 60 TOLL DENY TABLE / APPLY									
ENTRY	APPLY				ENTRY	APPLY			
	B	C	D	E		B	C	D	E

MMC 61 TOLL ALLOW TABLE / APPLY									
ENTRY	APPLY				ENTRY	APPLY			
	B	C	D	E		B	C	D	E

MMC 62 PBX ACCESS CODE			
PBX NO.	CODE	PBX NO.	CODE

COPY AS NEEDED

SHEET ____ OF ____

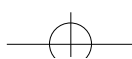



MMC 63 AUTHORIZATION CODE					
NO.	CODE	CLASS	NO.	CODE	CLASS

MMC 64 OVERRIDE TABLE					
NO.	CODE	NO.	CODE	NO.	CODE

MMC 65 WILD CHARACTER					
X :		Y :		Z :	

MMC 67 ASSIGN SYSTEM SPEED-DIAL			
NO.	SPEED DIAL NO.	NO.	SPEED-DIAL NO.

MMC 70 DIAL NUMBERING PLAN					
ENTRY	ACCESS CODE	ENTRY	ACCESS CODE	ENTRY	ACCESS CODE

MMC 71 / 72 KEY PROGRAMMING

NX-24E/NX-24B					
19:	20:	21:	22:	23:	24:
13:	14:	15:	16:	17:	18:
07:	08:	09:	10:	11:	12:
01:	02:	03:	04:	05:	06:

NX-12E/NX-12B					
07:	08:	09:	10:	11:	12:
01:	02:	03:	04:	05:	06:

NX-6B					
01:	02:	03:	04:	05:	06:

COPY AS NEEDED

SHEET ____ OF ____



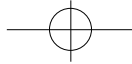

AS-30					
01:	02:	03:	04:	05:	06:
07:	08:	09:	10:	11:	12:
13:	14:	15:	16:	17:	18:
19:	20:	21:	22:	23:	24:
25:	26:	27:	28:	29:	30:

SKP-816						
09:	17:		01:	02:	03:	04:
10:	18:		05:	06:	07:	08:
11:	19:					
12:	20:					
13:	21:					
14:	22:					
15:	23:					
16:	24:					

NX-AOM	
01:	13:
02:	14:
03:	15:
04:	16:
05:	17:
06:	18:
07:	19:
08:	20:
09:	21:
10:	22:
11:	23:
12:	24:

MMC 80 IO PARAMETERS							
COM1	COM2	XON OFF		SMDR	REMOTE		TRAFFIC
		COM1	COM2		PORT	STN	

MMC 81 SMDR OPTIONS						
PAGE HEADER	LINE PER PAGE	INCOMING CALL	AUTHORX E CODE	LESS START TIME	ALARM	COMPANYNAME

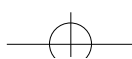



CODE: GA68-60655A
Edition : 05 DN
April 1999
Printed In Korea

